



# COM Express™ conga-BAF

*AMD G-Series Processor with AMD A55E Controller Hub*

*User's Guide*

*Revision 1.5*

# Revision History

Revision	Date (yyyy.mm.dd)	Author	Changes
0.1	2011.03.31	GDA	<ul style="list-style-type: none"> <li>Preliminary release</li> </ul>
1.0	2011.07.29	GDA	<ul style="list-style-type: none"> <li>Official release</li> </ul>
1.1	2012.07.13	GDA	<ul style="list-style-type: none"> <li>Minor updates throughout. Added maximum memory speed to Options Information table and Feature List table 1.</li> <li>Added note about HDMI and DisplayPort to section 4.2.4. Added note to table 4 'Gigabit Ethernet Signal Descriptions', table 12 "SPI BIOS Flash Interface Signal Descriptions" and table 22 "DisplayPort (DP) Signal Descriptions".</li> <li>Updated section 9 "BIOS Setup Description."</li> </ul>
1.2	2012.12.10	AEM	<ul style="list-style-type: none"> <li>Updated the power consumption tables in section 1.5 "Power Consumption".</li> <li>Changed maximum torque rating for heatspreader screws in section 3.1 "Heatspreader Dimensions" and added a caution statement.</li> <li>Updated section 4.1.12 "Power Control".</li> </ul>
1.3	2012.12.20	AEM	<ul style="list-style-type: none"> <li>Added Microsoft Windows 8 support in section 1.2 "Supported Operating System"</li> <li>Added the "#" sign to TMDS_B_HPD, TMDS_C_HPD, DPB_HPD, DPC_HPD signals to indicate that these signals are active low in table 21 "HDMI Signal Descriptions" and table 22 " DisplayPort Signal Descriptions".</li> </ul>
1.4	2013.04.02	AEM	<ul style="list-style-type: none"> <li>Deleted conga-BAF variants with part numbers 041002 and 041004 from "Options Information", section 1.1 "Feature List" and section 1.5 "Power Consumption".</li> <li>Deleted the feature "Critical Trip Point" from section 9.4.4 "ACPI Configuration Menu" because this feature is not available in the latest BIOS revision.</li> <li>Added the size of the BIOS binary in section 10 "Additional BIOS Features".</li> <li>Added section 10.1 "Supported Flash Devices".</li> </ul>
1.5	2013.07.09	AEM	<ul style="list-style-type: none"> <li>Added section 1 "Introduction". Moved COM Express™ Concept and Options Information to section 1 "Introduction".</li> <li>Deleted conga-BAF variants with part numbers 041002 and 041004 from "Options Information", section 2.1 "Feature List" and section 2.5 "Power Consumption".</li> <li>Updated the block diagram in section 3. Updated section 10 "BIOS Setup Description"</li> <li>Updated section 11.1 "Supported Flash Devices".</li> </ul>

## Preface

---

This user's guide provides information about the components, features, connectors and BIOS Setup menus available on the conga-BAF. It is one of three documents that should be referred to when designing a COM Express™ application. The other reference documents that should be used include the following:

COM Express™ Design Guide

COM Express™ Specification

The links to these documents can be found on the congatec AG website at [www.congatec.com](http://www.congatec.com)

## Disclaimer

The information contained within this user's guide, including but not limited to any product specification, is subject to change without notice.

congatec AG provides no warranty with regard to this user's guide or any other information contained herein and hereby expressly disclaims any implied warranties of merchantability or fitness for any particular purpose with regard to any of the foregoing. congatec AG assumes no liability for any damages incurred directly or indirectly from any technical or typographical errors or omissions contained herein or for discrepancies between the product and the user's guide. In no event shall congatec AG be liable for any incidental, consequential, special, or exemplary damages, whether based on tort, contract or otherwise, arising out of or in connection with this user's guide or any other information contained herein or the use thereof.

## Intended Audience

This user's guide is intended for technically qualified personnel. It is not intended for general audiences.

## Lead-Free Designs (RoHS)

All congatec AG designs are created from lead-free components and are completely RoHS compliant.

## Electrostatic Sensitive Device



All congatec AG products are electrostatic sensitive devices and are packaged accordingly. Do not open or handle a congatec AG product except at an electrostatic-free workstation. Additionally, do not ship or store congatec AG products near strong electrostatic, electromagnetic, magnetic, or radioactive fields unless the device is contained within its original manufacturer's packaging. Be aware that failure to comply with these guidelines will void the congatec AG Limited Warranty.

## Symbols

The following symbols are used in this user's guide:



### Warning

Warnings indicate conditions that, if not observed, can cause personal injury.



### Caution

Cautions warn the user about how to prevent damage to hardware or loss of data.



### Note

Notes call attention to important information that should be observed.

## Terminology

Term	Description
GB	Gigabyte (1,073,741,824 bytes)
GHz	Gigahertz (one billion hertz)
kB	Kilobyte (1024 bytes)
MB	Megabyte (1,048,576 bytes)
Mbit	Megabit (1,048,576 bits)
kHz	Kilohertz (one thousand hertz)
MHz	Megahertz (one million hertz)
TDP	Thermal Design Power
PCIe	PCI Express
SATA	Serial ATA
PEG	PCI Express Graphics
PCH	Platform Controller Hub
PATA	Parallel ATA
HDA	High Definition Audio
APU	Accelerated Processor Unit
CH	Controller Hub
DDI	Digital Display Interface
DP	DisplayPort
I/F	Interface

---

N.C.	Not connected
N.A.	Not available
TBD	To be determined

## Trademarks

Product names, logos, brands, and other trademarks featured or referred to within this user's guide, or the congatec website, are the property of their respective trademark holders. These trademark holders are not affiliated with congatec AG, our products, or our website.

## Warranty

congatec AG makes no representation, warranty or guaranty, express or implied regarding the products except its standard form of limited warranty ("Limited Warranty"). congatec AG may in its sole discretion modify its Limited Warranty at any time and from time to time.

Beginning on the date of shipment to its direct customer and continuing for the published warranty period, congatec AG represents that the products are new and warrants that each product failing to function properly under normal use, due to a defect in materials or workmanship or due to non conformance to the agreed upon specifications, will be repaired or exchanged, at congatec AG's option and expense.

Customer will obtain a Return Material Authorization ("RMA") number from congatec AG prior to returning the non conforming product freight prepaid. congatec AG will pay for transporting the repaired or exchanged product to the customer.

Repaired, replaced or exchanged product will be warranted for the repair warranty period in effect as of the date the repaired, exchanged or replaced product is shipped by congatec AG, or the remainder of the original warranty, whichever is longer. This Limited Warranty extends to congatec AG's direct customer only and is not assignable or transferable.

Except as set forth in writing in the Limited Warranty, congatec AG makes no performance representations, warranties, or guarantees, either express or implied, oral or written, with respect to the products, including without limitation any implied warranty (a) of merchantability, (b) of fitness for a particular purpose, or (c) arising from course of performance, course of dealing, or usage of trade.

congatec AG shall in no event be liable to the end user for collateral or consequential damages of any kind. congatec AG shall not otherwise be liable for loss, damage or expense directly or indirectly arising from the use of the product or from any other cause. The sole and exclusive remedy against congatec AG, whether a claim sound in contract, warranty, tort or any other legal theory, shall be repair or replacement of the product only

## Certification

congatec AG is certified to DIN EN ISO 9001 standard.



## Technical Support

congatec AG technicians and engineers are committed to providing the best possible technical support for our customers so that our products can be easily used and implemented. We request that you first visit our website at [www.congatec.com](http://www.congatec.com) for the latest documentation, utilities and drivers, which have been made available to assist you. If you still require assistance after visiting our website then contact our technical support department by email at [support@congatec.com](mailto:support@congatec.com)

# Contents

1	INTRODUCTION .....	10	5.1.10	LCD.....	24
2	Specifications.....	12	5.1.11	TV-Out.....	25
2.1	Feature List.....	12	5.1.12	Power Control .....	25
2.2	Supported Operating Systems.....	13	5.1.13	Power Management.....	27
2.3	Mechanical Dimensions .....	13	5.2	Secondary Connector Rows C and D .....	28
2.4	Supply Voltage Standard Power .....	14	5.2.1	PCI Express Graphics (PEG).....	28
2.4.1	Electrical Characteristics.....	14	5.2.2	SDVO.....	28
2.4.2	Rise Time .....	14	5.2.3	HDMI.....	28
2.5	Power Consumption.....	15	5.2.4	DisplayPort (DP) .....	28
2.5.1	conga-BAF AMD G-T56N 1.6 GHz Dual Core .....	16	5.2.5	PCI Bus.....	28
2.5.2	conga-BAF AMD G-T40N 1.0 GHz Dual Core .....	16	5.2.6	IDE (PATA) .....	29
2.5.3	conga-BAF AMD G-T40E 1.0 GHz Dual Core .....	16	6	Additional Features .....	30
2.5.4	conga-BAF AMD G-T44R 1.2 GHz Single Core .....	17	6.1	Watchdog .....	30
2.5.5	conga-BAF AMD G-T40R 1.0 GHz Single Core .....	17	6.2	Onboard Microcontroller .....	30
2.6	Supply Voltage Battery Power .....	17	6.3	Embedded BIOS .....	30
2.6.1	CMOS Battery Power Consumption .....	18	6.4	Security Features.....	31
2.7	Environmental Specifications.....	18	6.5	Suspend to Ram .....	31
3	Block Diagram.....	19	6.6	congatec Battery Management Interface .....	31
4	Heatspreader .....	20	7	conga Tech Notes .....	32
4.1	Heatspreader Dimensions .....	21	7.1	AHCI .....	32
5	Connector Subsystems Rows A, B, C, D.....	22	7.2	RAID .....	32
5.1	Primary Connector Rows A and B.....	23	7.3	Native vs. Compatible IDE mode .....	32
5.1.1	Serial ATA™ (SATA).....	23	7.3.1	Compatible Mode.....	32
5.1.2	USB 2.0.....	23	7.3.2	Native Mode .....	32
5.1.3	High Definition Audio (HDA) Interface.....	23	7.4	Thermal Management.....	33
5.1.4	Gigabit Ethernet .....	23	7.5	ACPI Suspend Modes and Resume Events .....	34
5.1.5	LPC Bus.....	23	7.6	HDMI/DisplayPort (DP) Audio Support .....	35
5.1.6	I <sup>2</sup> C Bus Fast Mode .....	24	8	Signal Descriptions and Pinout Tables.....	37
5.1.7	PCI Express™ .....	24	8.1	A-B Connector Signal Descriptions.....	38
5.1.8	ExpressCard™.....	24	8.2	A-B Connector Pinout .....	48
5.1.9	Graphics Output (VGA/CRT) .....	24	8.3	C-D Connector Signal Descriptions .....	50
			8.4	C-D Connector Pinout.....	61

8.5	Boot Strap Signals .....	63	10.7	Save & Exit Setup .....	89
9	System Resources .....	64	11	Additional BIOS Features .....	90
9.1	I/O Address Assignment .....	64	11.1	Supported Flash Devices .....	90
9.1.1	LPC Bus .....	64	11.2	Updating the BIOS .....	90
9.2	Interrupt Request (IRQ) Lines .....	65	11.3	BIOS Security Features .....	90
9.3	PCI Configuration Space Map .....	67	11.4	Hard Disk Security Features .....	91
9.4	PCI Interrupt Routing Map .....	69	12	Industry Specifications .....	92
9.5	PCI Bus Masters .....	70			
9.6	I <sup>2</sup> C Bus .....	70			
9.7	SM Bus .....	70			
10	BIOS Setup Description .....	71			
10.1	Entering the BIOS Setup Program .....	71			
10.1.1	Boot Selection Popup .....	71			
10.2	Setup Menu and Navigation .....	71			
10.3	Main Setup Screen .....	72			
10.4	Advanced Setup .....	73			
10.4.1	Graphics Configuration Submenu .....	74			
10.4.2	Watchdog Configuration Submenu .....	76			
10.4.3	PCI & PCI Express Configuration Submenu .....	77			
10.4.3.1	PIRQ Routing Submenu .....	78			
10.4.4	ACPI Configuration Submenu .....	79			
10.4.5	RTC Wake Settings Submenu .....	79			
10.4.6	Trusted Computing Configuration Submenu .....	80			
10.4.7	CPU Configuration Submenu .....	80			
10.4.8	Chipset Configuration Submenu .....	81			
10.4.9	Hardware Health Monitoring Submenu .....	82			
10.4.10	SATA/PATA Configuration Submenu .....	83			
10.4.11	USB Configuration Submenu .....	84			
10.4.11.1	Per-Port Legacy USB Support Control Submenu .....	85			
10.4.12	Super I/O Configuration Submenu .....	85			
10.4.13	Serial Port Console Redirection .....	86			
10.4.13.1	Console Redirection Settings Submenu .....	86			
10.5	Boot Setup .....	87			
10.5.1	Boot Settings Configuration .....	87			
10.6	Security Setup .....	89			
10.6.1	Security Settings Submenu .....	89			
10.6.2	Hard Disk Security Submenu .....	89			



# List of Tables

---

Table 1	Feature Summary .....	12
Table 2	Signal Tables Terminology Descriptions .....	37
Table 3	High Definition Audio Signals Descriptions .....	38
Table 4	Gigabit Ethernet Signal Descriptions .....	39
Table 5	Serial ATA Signal Descriptions .....	40
Table 6	PCI Express Signal Descriptions (general purpose) .....	40
Table 7	ExpressCard Support Pins Descriptions .....	41
Table 8	LPC Signal Descriptions .....	41
Table 9	USB Signal Descriptions .....	42
Table 10	CRT Signal Descriptions .....	42
Table 11	LVDS Signal Descriptions .....	43
Table 12	SPI BIOS Flash Interface Signal Descriptions .....	44
Table 13	Miscellaneous Signal Descriptions .....	45
Table 14	General Purpose I/O Signal Descriptions .....	45
Table 15	Power and System Management Signal Descriptions .....	46
Table 16	Power and GND Signal Descriptions .....	47
Table 17	Connector A-B Pinout .....	48
Table 18	PCI Signal Descriptions .....	50
Table 19	IDE Signal Descriptions .....	52
Table 20	PCI Express Signal Descriptions (x16 Graphics) .....	53
Table 21	HDMI Signal Descriptions .....	55
Table 22	DisplayPort (DP) Signal Descriptions .....	57
Table 23	Module Type Definition Signal Description .....	59
Table 24	Power and GND Signal Descriptions .....	59
Table 25	Miscellaneous Signal Descriptions .....	60
Table 26	Connector C-D Pinout .....	61
Table 27	Boot Strap Signal Descriptions .....	63
Table 28	IRQ Lines in PIC mode .....	65
Table 29	IRQ Lines in APIC mode .....	66
Table 30	PCI Configuration Space Map .....	67
Table 31	PCI Interrupt Routing Map .....	69
	PCI Interrupt Routing Map (continued) .....	69

# 1 INTRODUCTION

## COM Express™ Concept

COM Express™ is an open industry standard defined specifically for COMs (computer on modules). It's creation provides the ability to make a smooth transition from legacy parallel interfaces to the newest technologies based on serial buses available today. COM Express™ modules are available in following form factors:

- Compact      95mm x 95mm
- Basic          125mm x 95mm
- Extended     155mm x 110mm

The COM Express™ specification 2.0 defines five different pinout types.

Types	Connector Rows	PCI Express Lanes	PCI	IDE Channels	LAN ports
Type 1	A-B	Up to 6			1
Type 2	A-B C-D	Up to 22	32 bit	1	1
Type 3	A-B C-D	Up to 22	32 bit		3
Type 4	A-B C-D	Up to 32		1	1
Type 5	A-B C-D	Up to 32			3
Type 6	A-B C-D	Up to 24			1
Type 10	A-B	Up to 4			1

congatec AG modules utilize the Type 2 pinout definition. They are equipped with two high performance connectors that ensure stable data throughput.

The COM (computer on module) integrates all the core components and is mounted onto an application specific carrier board. COM modules are a legacy-free design (no Super I/O, PS/2 keyboard and mouse) and provide most of the functional requirements for any application. These functions include, but are not limited to, a rich complement of contemporary high bandwidth serial interfaces such as PCI Express, Serial ATA, USB 2.0, and Gigabit Ethernet. The Type 2 pinout provides the ability to offer 32-bit PCI, Parallel ATA, and LPC options thereby expanding the range of potential peripherals. The robust thermal and mechanical concept, combined with extended power-management capabilities, is perfectly suited for all applications.

Carrier board designers can utilize as little or as many of the I/O interfaces as deemed necessary. The carrier board can therefore provide all the interface connectors required to attach the system to the application specific peripherals. This versatility allows the designer to create a dense and optimized package, which results in a more reliable product while simplifying system integration. Most importantly, COM Express™ modules are scalable, which means once an application has been created there is the ability to diversify the product range through the use of different performance class or form factor size modules. Simply unplug one module and replace it with another, no redesign is necessary.

## conga-BAF Options Information

The conga-BAF is available in five different variants. This user's guide describes all of these variants. The tables below show the different configurations available. Check for the Part No. that applies to your product. This will tell you what options described in this user's guide are available on your particular module.

### conga-BAF

Part-No.	041001	041003	041007	041005	041006
<b>Processor</b>	AMD G-T56N 1.6 GHz Dual Core	AMD G-T40N 1.0 GHz Dual Core	AMD G-T40E 1.0 GHz Dual Core	AMD G-T44R 1.2 GHz Single Core	AMD G-T40R 1.0 GHz Single Core
<b>DDR3 Speed</b>	DDR3-1333	DDR3-1066	DDR3-1066	DDR3-1066	DDR3-1066
<b>L2 Cache</b>	512kB x2	512kB x2	512kB x2	512kB	512kB x2
<b>PEG</b>	No	No	No	No	No
<b>Graphics</b>	Radeon™ HD 6320	Radeon™ HD 6290	Radeon™ HD 6250	Radeon™ HD 6250	Radeon™ HD 6250
<b>LVDS</b>	Yes (uses APU DP0 port)	Yes (uses APU DP0 port)	Yes (uses APU DP0 port)	Yes (uses APU DP0 port)	Yes (uses APU DP0 port)
<b>DisplayPort (DP)</b>	Yes (shared with HDMI)	Yes (shared with HDMI)	Yes (shared with HDMI)	Yes (shared with HDMI)	Yes (shared with HDMI)
<b>HDMI</b>	Yes (shared with DP)	Yes (shared with DP)	Yes (shared with DP)	Yes (shared with DP)	Yes (shared with DP)
<b>Processor TDP</b>	18 W	9 W	6.4 W	9 W	5.5 W

## 2 Specifications

### 2.1 Feature List

**Table 1 Feature Summary**

<b>Form Factor</b>	Based on COM Express™ standard pinout Type 2 Rev. 2.0 (Basic size 95 x 125mm)	
<b>Processor</b>	AMD G-T56N 1.6 GHz Dual Core L2 cache 512kB x2 AMD G-T40N 1.0 GHz Dual Core L2 cache 512kB x2 AMD G-T40E 1.0 GHz Dual Core L2 cache 512kB x2 AMD G-T44R 1.2 GHz Single Core L2 cache 512kB AMD G-T40R 1.0 GHz Single Core L2 cache 512kB	
<b>Memory</b>	2 sockets: SO-DIMM DDR3 1333 MT/s (666MHz) and 1066 MT/s (533 MHz) up to 8-GByte total. Sockets located top and bottom side of module.	
<b>Chipset</b>	A55E Controller Hub	
<b>Audio</b>	HDA (High Definition Audio)/digital audio interface with support for multiple codecs	
<b>Ethernet</b>	Gigabit Ethernet: Realtek RTL8111E	
<b>Graphics Options</b>	Integrated high-performance video, DirectX®11 graphics with UVD 3.0, Integrated VGA DAC. Supports dual simultaneous display. <ul style="list-style-type: none"> <li>• 400 MHz RAMDAC, resolutions up to 1920x1200 (WUXGA)</li> <li>• Flat panel interface (provided by Analogix ANX3110 DisplayPort to LVDS converter). Supports:             <ul style="list-style-type: none"> <li>• Single-channel LVDS interface : 1 x 18 bpp or 1 x 24 bpp:</li> <li>• Dual-channel LVDS interface : 2 x 18 bpp or 2 x 24 bpp panel support</li> <li>• VESA standard or JEDIA data mapping.</li> <li>• Automatic Panel Detection via EDID/EPI (Embedded Panel Interface based on VESA EDID™ 1.3)</li> <li>• Resolutions 800x600 up to 1920x1200 (WUXGA) @ 60 Hz</li> </ul> </li> <li>• 2x DisplayPort 1.1a, resolutions up to 1920x1200, shared with HDMI port</li> <li>• 2x HDMI 1.3a Port, resolution up to 1920x1080, shared with DisplayPort</li> <li>• 1x DisplayPort/HDMI port is used for LVDS if module supports LVDS</li> </ul>	
<b>Peripheral Interfaces</b>	<ul style="list-style-type: none"> <li>• 4x Serial ATA® RAID 0,1 support.</li> <li>• 6x x1 PCI Express® Links. Support for full Gen 2 @ 5 Gb/s bandwidth in each direction per x1 link (can be configured via software to support six x1s or one x4 and two x1 port widths).</li> <li>• 8x USB 2.0 (EHCI)</li> </ul>	<ul style="list-style-type: none"> <li>• PCI Bus Rev. 2.3</li> <li>• 1x EIDE (UDMA-66/100)</li> <li>• LPC Bus</li> <li>• I²C Bus, Fast Mode multimaster</li> </ul>
<b>BIOS</b>	AMI Aptio® UEFI 2.x firmware, 4MByte serial SPI with congatec Embedded BIOS features	
<b>Power Management</b>	ACPI 3.0 compliant with battery support. Also supports Suspend to RAM (S3).	



*Some of the features mentioned in the above Feature Summary are optional. Check the article number of your module and compare it to the option information list on page 11 of this user's guide to determine what options are available on your particular module.*

## 2.2 Supported Operating Systems

The conga-BAF supports the following operating systems.

- Microsoft® Windows® 8 (32 and 64 bit)
- Microsoft® Windows® 7 (32 and 64 bit)
- Microsoft® Windows® 7 Embedded
- Microsoft® Windows® XP
- Microsoft® Windows® XP Embedded
- Linux



### Note

*To improve the performance of conga-BAF after installing Microsoft® Windows® 8 (32 and 64 bit), congatec AG recommends the installation of AMD catalyst driver.*

## 2.3 Mechanical Dimensions

- 95.0 mm x 125.0 mm (3.74" x 4.92")
- Height approximately 18 or 21mm (including heatspreader) depending on the carrier board connector that is used. If the 5mm (height) carrier board connector is used then approximate overall height is 18mm. If the 8mm (height) carrier board connector is used then approximate overall height is 21mm.

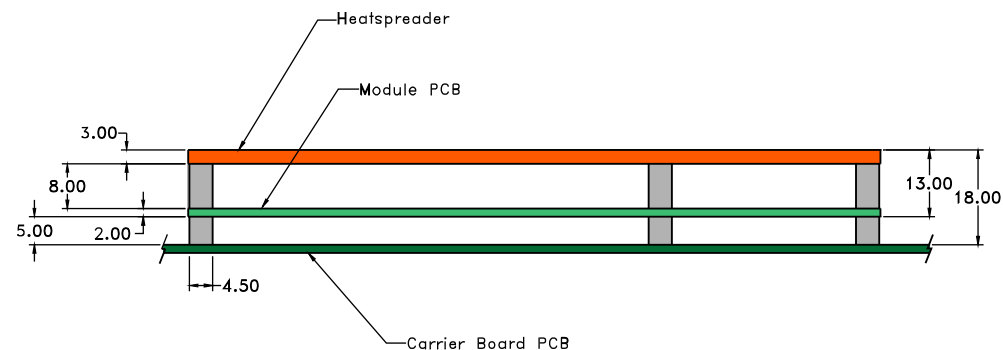

## 2.4 Supply Voltage Standard Power

- 12V DC  $\pm$  5%

The dynamic range shall not exceed the static range.

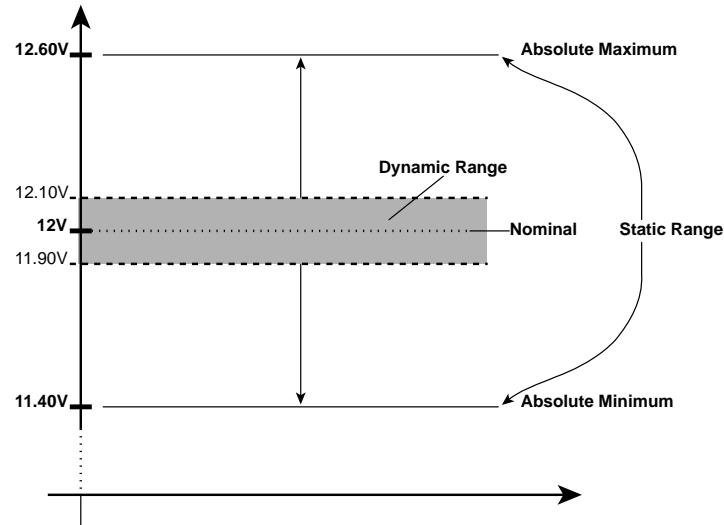

### 2.4.1 Electrical Characteristics

Power supply pins on the module's connectors limit the amount of input power. The following table provides an overview of the limitations for pinout Type 2 (dual connector, 440 pins).

Power Rail	Module Pin Current Capability (Amps)	Nominal Input (Volts)	Input Range (Volts)	Derated Input (Volts)	Max. Input Ripple (10Hz to 20MHz) (mV)	Max. Module Input Power (w. derated input) (Watts)	Assumed Conversion Efficiency	Max. Load Power (Watts)
VCC_12V	16.5	12	11.4-12.6	11.4	+/- 100	137	85%	116
VCC_5V-SBY	2	5	4.75-5.25	4.75	+/- 50	9		
VCC_RTC	0.5	3	2.0-3.3		+/- 20			

### 2.4.2 Rise Time

The input voltages shall rise from 10% of nominal to 90% of nominal at a minimum slope of 250V/s. The smooth turn-on requires that during the 10% to 90% portion of the rise time, the slope of the turn-on waveform must be positive.

## 2.5 Power Consumption

The power consumption values listed in this document were measured under a controlled environment. The hardware used includes a conga-BAF module, conga-CEVAL and conga-Cdebug carrier boards, CRT monitor, SATA drive, and USB keyboard. When using the conga-Cdebug, the SATA drive was powered externally by an ATX power supply so that it does not influence the power consumption value that is measured for the module. The USB keyboard was detached once the module was configured within the OS. The module was first inserted into the conga-Cdebug, which was powered by a Direct Current (DC) power supply set to output 12V. The current consumption value displayed by the DC power supply's readout is the value that is recorded as the power consumption measurement for Desktop Idle, 100% Workload and Standby modes. The power consumption of the conga-Cdebug (without module attached) was measured and this value was later subtracted from the overall power consumption value measured when the module and all peripherals were connected. All recorded values are approximate.

The conga-Cdebug does not provide 5V Standby power therefore S3 mode was measured using the conga-CEVAL powered by an ATX power supply with a multimeter attached to the 5V Standby power line. The 5V Standby power consumption of the conga-CEVAL (without module attached) and all peripherals connected was first measured and the resulting value was later subtracted from the overall S3 power consumption value measured when the module was attached. All S3 recorded values are approximate.

Each module was measured while running Windows XP Professional with SP3 (service pack 3) and the "Power Scheme" was set to "Portable/Laptop". This setting ensures that Core™ processors run in LFM (lowest frequency mode) with minimal core voltage during desktop idle. Each module was tested while using a 2GB memory module. Using different sizes of RAM, as well as two memory modules, will cause slight variances in the measured results.

Power consumption values were recorded during the following stages:

### Windows XP Professional SP3

- Desktop Idle
- 100% CPU workload (see note below)
- Suspend to RAM. Supply power for S3 mode is 5V.



#### Note

*A software tool was used to stress the CPU to Max Frequency.*

## 2.5.1 conga-BAF AMD G-T56N 1.6 GHz Dual Core

With 2GB memory installed

conga-BAF Art. No. 041001		AMD G-T56N 1.6 GHz Dual Core 512kB x2 Cache 40nm Layout Rev. BBRALA0 /BIOS Rev. BBRAR005		
Memory Size	2GB			
Operating System	Windows XP SP3			
Power State	Desktop Idle	100% workload	Suspend to Ram (S3) 5V Input Power	
Power consumption (measured in Amperes/Watts)	1.30 A/6.5 W (12V)	2.80 A/14.0 W (12V)	0.10 A/0.30 W (5V)	

## 2.5.2 conga-BAF AMD G-T40N 1.0 GHz Dual Core

With 2GB memory installed

conga-BAF Art. No. 041003		AMD G-T40N 1.0 GHz Dual Core 512kB x2 Cache 40nm Layout Rev. BBRALA0 /BIOS Rev. BBRAR005		
Memory Size	2GB			
Operating System	Windows XP SP3			
Power State	Desktop Idle	100% workload	Suspend to Ram (S3) 5V Input Power	
Power consumption (measured in Amperes/Watts)	0.50 A/6.0 W (12V)	0.90 A/11.0 W (12V)	0.10 A/0.30 W (5V)	

## 2.5.3 conga-BAF AMD G-T40E 1.0 GHz Dual Core

With 2GB memory installed

conga-BAF Art. No. 041007		AMD G-T40E 1.0 GHz Dual Core 512kB x2 Cache 40nm Layout Rev. BBRALA0 /BIOS Rev. BBRAR005		
Memory Size	2GB			
Operating System	Windows 7 (32 bit)			
Power State	Desktop Idle	100% workload	Suspend to Ram (S3) 5V Input Power	
Power consumption (measured in Amperes/Watts)	0.50 A/6.20 W (12V)	0.80 A/ 9.10 W (12V)	0.1 A/ 0.30 W (5V)	



## 2.5.4 conga-BAF AMD G-T44R 1.2 GHz Single Core

With 2GB memory installed

conga-BAF Art. No. 041005		AMD G-T44R 1.2 GHz Dual Core 512kB Cache 40nm Layout Rev. BBRALA0 /BIOS Rev. BBRAR005		
Memory Size	2GB			
Operating System	Windows XP SP3			
Power State	Desktop Idle	100% workload	Suspend to Ram (S3) 5V Input Power	
Power consumption (measured in Amperes/Watts)	0.50 A/6.40 W (12V)	0.80 A/10.0 W (12V)	0.1 A/0.30 W (5V)	

## 2.5.5 conga-BAF AMD G-T40R 1.0 GHz Single Core

With 2GB memory installed

conga-BAF Art. No. 041006		AMD G-T40R 1.0 GHz Dual Core 512kB Cache 40nm Layout Rev. BBRALA0 /BIOS Rev. BBRAR005		
Memory Size	2GB			
Operating System	Windows XP SP3			
Power State	Desktop Idle	100% workload	Suspend to Ram (S3) 5V Input Power	
Power consumption (measured in Amperes/Watts)	0.50 A/5.80 W (12V)	0.60 A/7.70 W (12V)	0.1 A/0.3 W (5V)	



### Note

All recorded power consumption values are approximate and only valid for the controlled environment described earlier. 100% workload refers to the CPU workload and not the maximum workload of the complete module. Supply power for S3 mode is 5V while all other measured modes are supplied with 12V power. Power consumption results will vary depending on the workload of other components such as graphics engine, memory, etc.

## 2.6 Supply Voltage Battery Power

- 2.5V-3.6V DC
- Typical 3V DC

## 2.6.1 CMOS Battery Power Consumption

RTC @ 20°C	Voltage	Current
Integrated in the AMD A55E FCH	3V DC	2.06 µA

The CMOS battery power consumption value listed above should not be used to calculate CMOS battery lifetime. You should measure the CMOS battery power consumption in your customer specific application in worst case conditions, for example during high temperature and high battery voltage. The self-discharge of the battery must also be considered when determining CMOS battery lifetime. For more information about calculating CMOS battery lifetime refer to application note AN9\_RTC\_Battery\_Lifetime.pdf, which can be found on the congatec AG website at [www.congatec.com](http://www.congatec.com).

## 2.7 Environmental Specifications

Temperature	Operation: 0° to 60°C	Storage: -20° to +80°C
Humidity	Operation: 10% to 90%	Storage: 5% to 95%



### Caution

*The above operating temperatures must be strictly adhered to at all times. When using a heatspreader the maximum operating temperature refers to any measurable spot on the heatspreader's surface.*

*congatec AG strongly recommends that you use the appropriate congatec module heatspreader as a thermal interface between the module and your application specific cooling solution.*

*If for some reason it is not possible to use the appropriate congatec module heatspreader, then it is the responsibility of the operator to ensure that all components found on the module operate within the component manufacturer's specified temperature range.*

*For more information about operating a congatec module without heatspreader contact congatec technical support.*

*Humidity specifications are for non-condensing conditions.*

# 3 Block Diagram

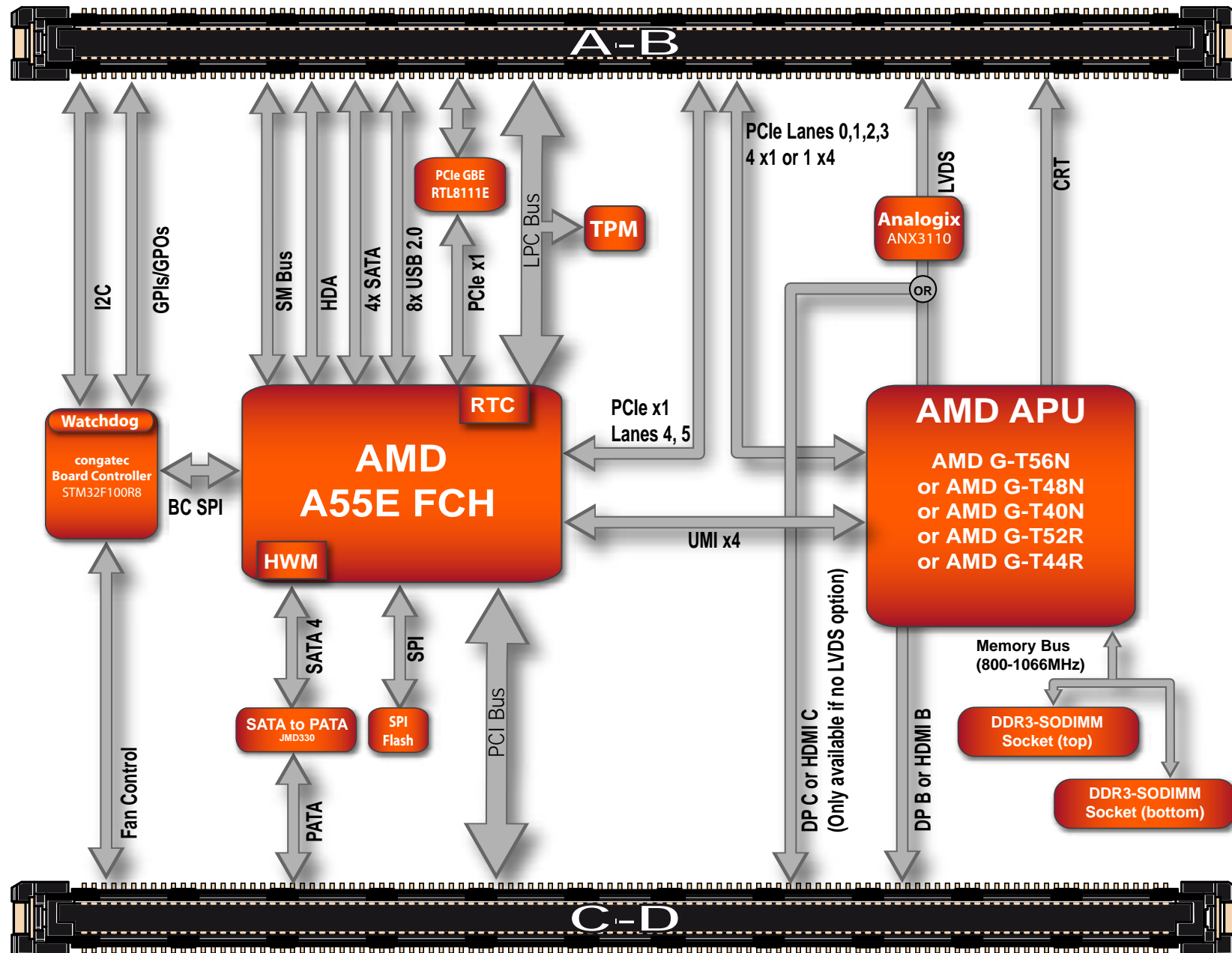

## 4 Heatspreader

An important factor for each system integration is the thermal design. The heatspreader acts as a thermal coupling device to the module and its aluminum plate is 3mm thick.

The heatspreader is thermally coupled to the CPU via a thermal gap filler and on some modules it may also be thermally coupled to other heat generating components with the use of additional thermal gap fillers.

Although the heatspreader is the thermal interface where most of the heat generated by the module is dissipated, it is not to be considered as a heatsink. It has been designed as a thermal interface between the module and the application specific thermal solution. The application specific thermal solution may use heatsinks with fans, and/or heat pipes, which can be attached to the heatspreader. Some thermal solutions may also require that the heatspreader is attached directly to the systems chassis thereby using the whole chassis as a heat dissipater.



### Caution

*There are mounting holes on the heatspreader designed to attach the heatspreader to the module. These mounting holes must be used to ensure that all components that are required to make contact with heatspreader do so. Failure to utilize these mounting holes will result in improper contact between these components and heatspreader thereby reducing heat dissipation efficiency.*

*Attention must be given to the mounting solution used to mount the heatspreader and module into the system chassis. Do not use a threaded heatspreader together with threaded carrier board standoffs. The combination of the two threads may be staggered, which could lead to stripping or cross-threading of the threads in either the standoffs of the heatspreader or carrier board.*

*Only heatspreaders that feature pilot pins that secure the thermal stacks should be used for applications that require the heatspreader to be mounted vertically. It cannot be guaranteed that the thermal stacks will not move if a heatspreader that does not have the pilot pin feature is used in vertically mounted applications.*

*Additionally, the gap pad material used on all heatspreaders contains silicon oil that can seep out over time depending on the environmental conditions it is subjected to. For more information about this subject, contact your local congatec sales representative and request the gap pad material manufacturer's specification.*

## 4.1 Heatspreader Dimensions

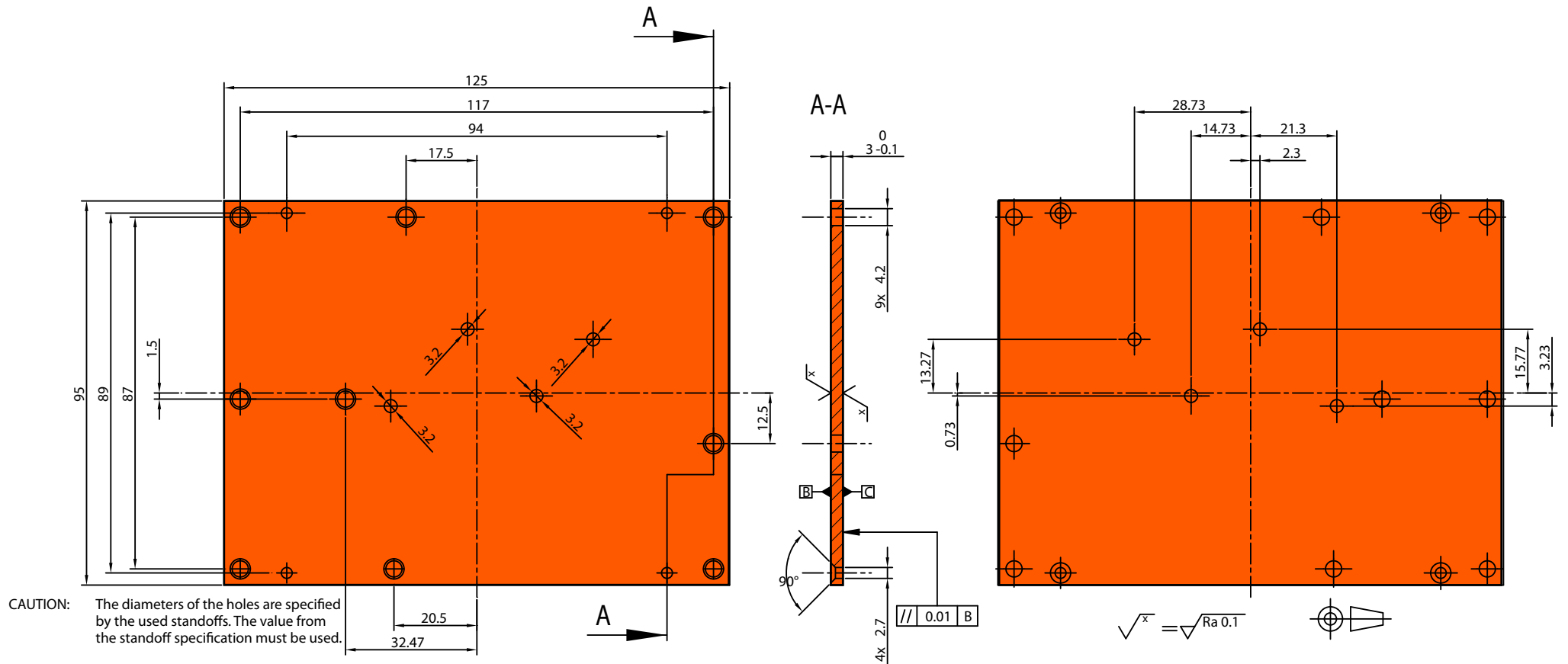

## 5 Connector Subsystems Rows A, B, C, D

The conga-BAF is connected to the carrier board via two 220-pin connectors (COM Express Type 2 pinout) for a total of 440 pins connectivity. These connectors are broken down into four rows. The primary connector consists of rows A and B while the secondary connector consists of rows C and D.

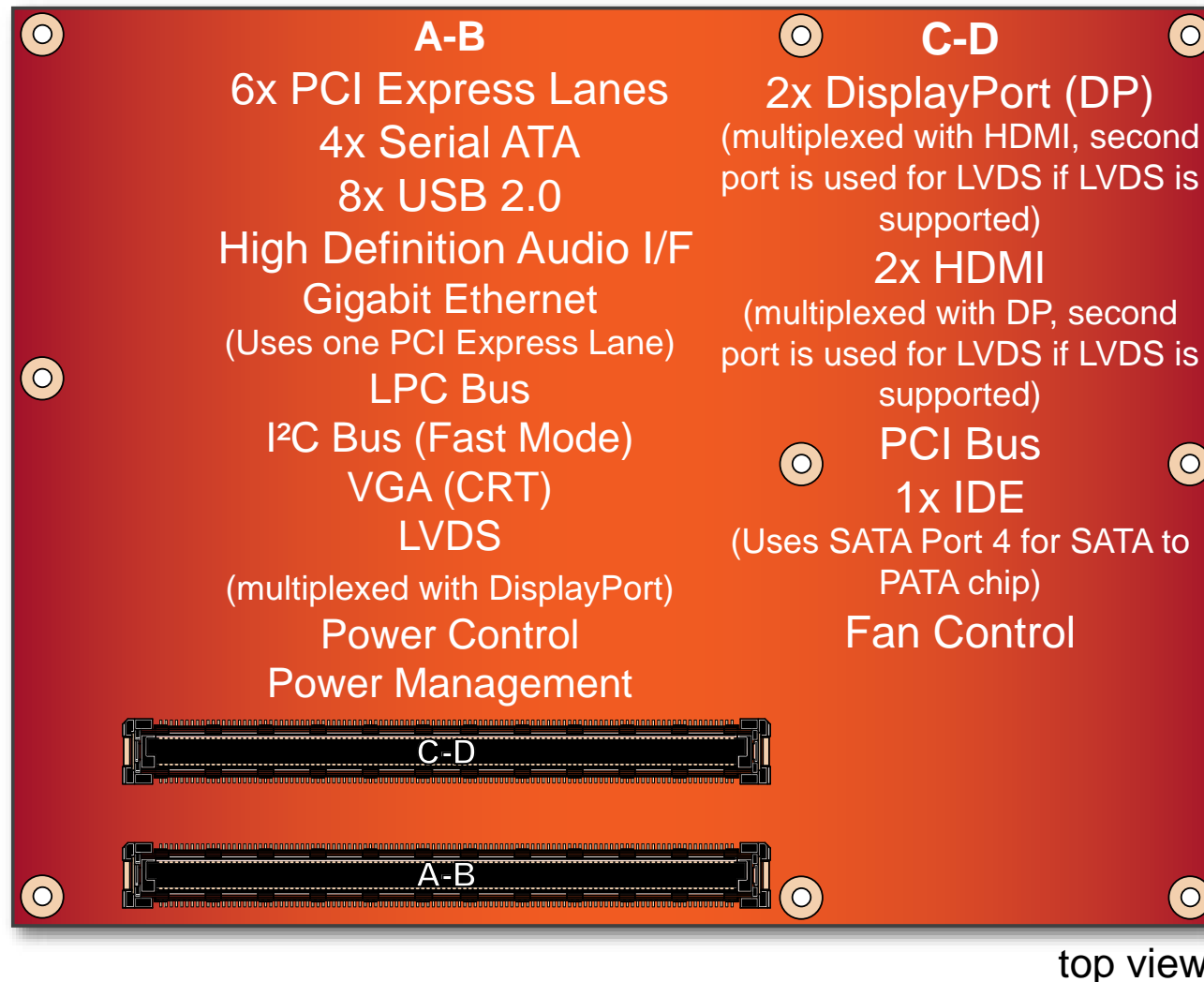

In this view the connectors are seen “through” the module.

## 5.1 Primary Connector Rows A and B

The following subsystems can be found on the primary connector rows A and B.

### 5.1.1 Serial ATA™ (SATA)

Four Serial ATA connections are provided via the AMD A55E Controller Hub (FCH). These SATA ports (0, 1, 2, 3) are SATA 2 compliant and capable of up to 3Gbit/s transfer rate. SATA is completely protocol and software compatible to parallel ATA. The SATA ports support legacy, AHCI and RAID 0,1,5 and 10 operating modes.

### 5.1.2 USB 2.0

The conga-BAF offers 8 USB host ports provided by the AMD A55E FCH. These ports comply with USB standard 1.1 and 2.0 and routed to connector rows A and B. Each port is capable of supporting USB 1.1 and 2.0 compliant devices.

### 5.1.3 High Definition Audio (HDA) Interface

The conga-BAF provides an interface that supports the connection of HDA audio codecs.

### 5.1.4 Gigabit Ethernet

The conga-BAF is equipped with a Realtek RTL8111 Gigabit Ethernet Controller. This controller is implemented through the use of a x1 PCI Express link. The Ethernet interface consists of 4 pairs of low voltage differential pair signals designated from GBE0\_MD0<sub>±</sub> to GBE0\_MD3<sub>±</sub> plus control signals for link activity indicators. These signals can be used to connect to a 10/100/1000 BaseT RJ45 connector with integrated or external isolation magnetics on the carrier board.

### 5.1.5 LPC Bus

conga-BAF offers the LPC (Low Pin Count) bus through the use of the AMD A55E FCH. There are many devices available for this bus. The LPC bus corresponds approximately to a serialized ISA bus yet with a significantly reduced number of signals. Due to the software compatibility to the ISA bus, I/O extensions such as additional serial ports can be easily implemented on an application specific baseboard using this bus.

## 5.1.6 I<sup>2</sup>C Bus Fast Mode

The I<sup>2</sup>C bus is implemented through the use of STMicroelectronics STM32F100R8 microcontroller and accessed through the congatec CGOS driver and API. It provides a fast mode multi-master I<sup>2</sup>C bus that has maximum I<sup>2</sup>C bandwidth.

## 5.1.7 PCI Express™

The conga-BAF offers 6x PCI Express™ Gen 2 lanes. Four of these lanes (0, 1, 2, 3) are provided by the AMD APU and the remaining two lanes (4,5) are provided by the A55E FCH. All of these lanes can be configured to support PCI Express edge cards or ExpressCards. The PCI Express™ interface offers support for full 5 Gb/s bandwidth in each direction per lane.

The lanes can be configured via BIOS setup options as specific links. Lanes 0, 1, 2, 3 can be configured as one x4 link or 4 x1 links. Lanes 4 and 5 are configured as 2 x1 links.



### Note

*Some PCI Express devices may have a problem if IRQ 6 or IRQ 12 is assigned to the device. In this case it's necessary to manually assign an IRQ for the device via the PIRQ Routing Submenu found in the BIOS setup program. For more information about this setup node see section 10.4.3.1 of this document.*

## 5.1.8 ExpressCard™

The conga-BAF supports the implementation of ExpressCards, which requires the dedication of one USB 2.0 port and one x1 PCI Express link for each ExpressCard used.

## 5.1.9 Graphics Output (VGA/CRT)

The conga-BAF features integrated high performance video within the AMD APU. It supports DirectX®11 graphics with UVD 3.0, integrated VGA DAC, and dual simultaneous display.

## 5.1.10 LCD

The conga-BAF offers a dual channel LVDS interface. This interface is provided through the use of Analogix ANX3110 attached to one of the two APU display channels. ANX3110 is a low cost high quality DisplayPort™ to LVDS converter offering up to 24 bits per pixel and single/dual channel LVDS output support. If the LVDS option (default) is present then the second DisplayPort/HDMI port is not available.



## 5.1.11 TV-Out

Integrated TV-Out support is not supported on the conga-BAF

## 5.1.12 Power Control

### PWR\_OK

Power OK from main power supply or carrier board voltage regulator circuitry. A high value indicates that the power is good and the module can start its onboard power sequencing. Carrier board hardware must drive this signal low until all power rails and clocks are stable. Releasing PWR\_OK too early or not driving it low at all can cause numerous boot up problems. It is a good design practice to delay the PWR\_OK signal a little (typically 100ms) after all carrier board power rails are up, to ensure a stable system. See screenshot below.

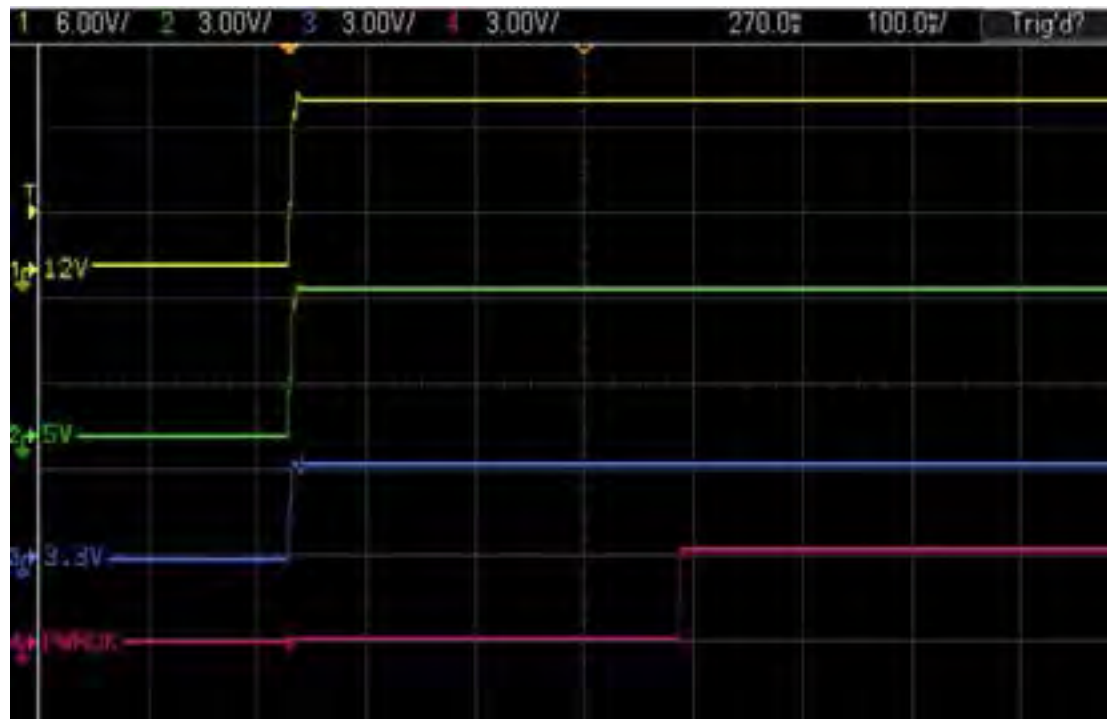

*The module is kept in reset as long as the PWR\_OK is driven by carrier board hardware.*

The conga-BAF PWR\_OK input circuitry is implemented as shown below:

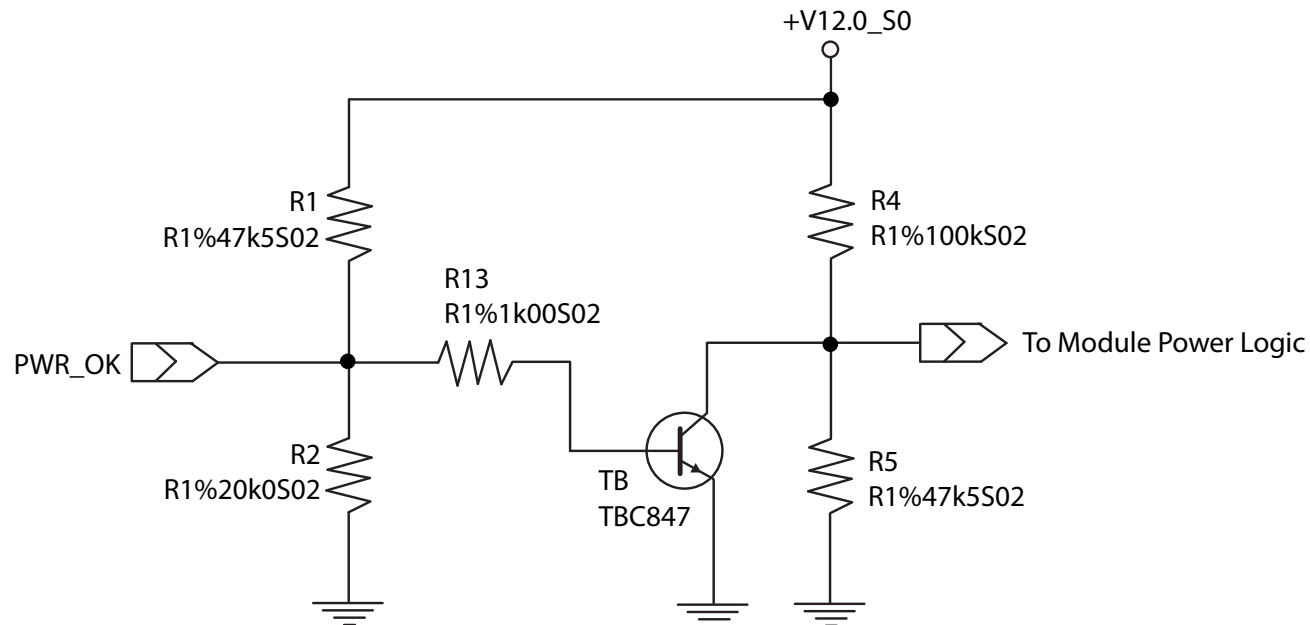

The voltage divider ensures that the input complies with 3.3V CMOS characteristic and also allows for carrier board designs that are not driving PWR\_OK. Although the PWR\_OK input is not mandatory for the onboard power-up sequencing, it is strongly recommended that the carrier board hardware drives the signal low until it is safe to let the module boot-up.

When considering the above shown voltage divider circuitry and the transistor stage, the voltage measured at the PWR\_OK input pin may be only around 0.8V when the 12V is applied to the module. Actively driving PWR\_OK high is compliant to the COM Express specification but this can cause back driving. Therefore, congatec recommends driving the PWR\_OK low to keep the module in reset and tri-state PWR\_OK when the carrier board hardware is ready to boot.

The three typical usage scenarios for a carrier board design are:

- Connect PWR\_OK to the “power good” signal of an ATX type power supply.
- Connect PWR\_OK to the last voltage regulator in the chain on the carrier board.
- Simply pull PWR\_OK with a 1k resistor to the carrier board 3.3V power rail.

With this solution, it must be ensured that by the time the 3.3V is up, all carrier board hardware is fully powered and all clocks are stable.

The conga-BAF provides support for controlling ATX-style power supplies. When not using an ATX power supply then the conga-BAF's pins SUS\_S3#/PS\_ON#, 5V\_SB#, and PWRBTN# should be left unconnected.

### **SUS\_S3#/PS\_ON#**

The SUS\_S3#/PS\_ON# (pin A15 on the A-B connector) signal is an active-low output that can be used to turn on the main outputs of an ATX-style power supply. In order to accomplish this the signal must be inverted with an inverter/transistor that is supplied by standby voltage and is located on the carrier board.

### **PWRBTN#**

When using ATX-style power supplies PWRBTN# (pin B12 on the A-B connector) is used to connect to a momentary-contact, active-low debounced push-button input while the other terminal on the push-button must be connected to ground. This signal is internally pulled up to 3V\_SB using a 10k resistor. When PWRBTN# is asserted it indicates that an operator wants to turn the power on or off. The response to this signal from the system may vary as a result of modifications made in BIOS settings or by system software.

## **Power Supply Implementation Guidelines**

12 volt input power is the sole operational power source for the conga-BAF. The remaining necessary voltages are internally generated on the module using onboard voltage regulators. A carrier board designer should be aware of the following important information when designing a power supply for a conga-BAF application:

- It has also been noticed that on some occasions problems occur when using a 12V power supply that produces non monotonic voltage when powered up. The problem is that some internal circuits on the module (e.g. clock-generator chips) will generate their own reset signals when the supply voltage exceeds a certain voltage threshold. A voltage dip after passing this threshold may lead to these circuits becoming confused resulting in a malfunction. It must be mentioned that this problem is quite rare but has been observed in some mobile power supply applications. The best way to ensure that this problem is not encountered is to observe the power supply rise waveform through the use of an oscilloscope to determine if the rise is indeed monotonic and does not have any voltage dips. This should be done during the power supply qualification phase therefore ensuring that the above mentioned problem doesn't arise in the application. For more information about this issue visit [www.formfactors.org](http://www.formfactors.org) and view page 25 figure 7 of the document "ATX12V Power Supply Design Guide V2.2".

### **5.1.13 Power Management**

ACPI 3.0 compliant with battery support. Also supports Suspend to RAM (S3).

## 5.2 Secondary Connector Rows C and D

The following subsystems can be found on the secondary connector rows C and D.

### 5.2.1 PCI Express Graphics (PEG)

The PCI Express graphics interface is not supported by the conga-BAF.

### 5.2.2 SDVO

SDVO is not supported on the conga-BAF.

### 5.2.3 HDMI

The conga-BAF supports two HDMI 1.3a ports that are shared with the two DisplayPort outputs. Only one HDMI port is available if the LVDS feature (default) is implemented on the conga-BAF since one port is required for the Analogix ANX3110 DisplayPort to LVDS converter.

### 5.2.4 DisplayPort (DP)

The conga-BAF supports two DisplayPort 1.1a ports that are shared with the two HDMI ports. Only one DisplayPort port is available if the LVDS feature (default) is supported on the conga-BAF since one port is required for the Analogix ANX3110 DisplayPort to LVDS converter.



#### Note

*Unlike other congatec Type 2 COM Express modules with HDMI and DisplayPort support, the conga-BAF offers only one interface (pins C58 and C59 for port B and pins C71 and C72 for port C) for the HDMI control clock/data and DisplayPort auxiliary channel signals. Carrier board HDMI implementation designed according to Table 1 of the congatec application note, AN17\_HDMI\_DP\_Implementation “Implementation Guide for HDMI and DisplayPort interface” will not work due to the HDMI control bus pinout described above. This is also true when using HDMI via the conga-HDMI/DisplayPort adapter card. Refer to application note ‘AN17\_HDMI\_DP\_Implementation’ for more information about the routing of the Digital Display interfaces on congatec Type 2 COM Express modules.*

### 5.2.5 PCI Bus

The PCI bus complies with PCI specification Rev. 2.3 and provides a 32bit parallel PCI bus that is capable of operating at 33MHz.

 **Note**

*The PCI interface is specified to be +5V tolerant, with +3.3V signaling.*

## 5.2.6 IDE (PATA)

The conga-BAF supports an IDE channel that is capable of UDMA-33/66/100 operation. This channel is implemented by converting SATA Port 4 to an IDE channel using JMicron's single chip solution for serial to parallel ATA translation. The IDE interface supports the connection of only **one device** at any given moment and this device operates in **Master mode** only.

## 6 Additional Features

---

### 6.1 Watchdog

The conga-BAF is equipped with a multi stage watchdog solution that is triggered by software. The COM Express™ Specification does not provide support for external hardware triggering of the Watchdog, which means the conga-BAF does not support external hardware triggering. For more information about the Watchdog feature see the BIOS setup description section 10.4.2 of this document and application note AN3\_Watchdog.pdf on the congatec AG website at [www.congatec.com](http://www.congatec.com).

### 6.2 Onboard Microcontroller

The conga-BAF is equipped with an STMicroelectronics STM32F100R8 microcontroller. This onboard microcontroller plays an important role for most of the congatec BIOS features. It fully isolates some of the embedded features such as system monitoring or the I<sup>2</sup>C bus from the x86 core architecture, which results in higher embedded feature performance and more reliability, even when the x86 processor is in a low power mode.

### 6.3 Embedded BIOS

The conga-BAF is equipped with congatec Embedded BIOS and has the following features:

- ACPI Power Management
- ACPI Battery Support
- Supports Customer Specific CMOS Defaults
- Multistage Watchdog
- User Data Storage
- Manufacturing Data and Board Information
- OEM Splash Screen
- Flat Panel Auto Detection and Backlight Control
- BIOS Setup Data Backup
- Fast Mode I<sup>2</sup>C Bus

## 6.4 Security Features

The conga-BAF can be equipped optionally with a “Trusted Platform Module“ (TPM 1.2). This TPM 1.2 includes coprocessors to calculate efficient hash and RSA algorithms with key lengths up to 2,048 bits as well as a real random number generator. Security sensitive applications like gaming and e-commerce will benefit also with improved authentication, integrity and confidence levels.

## 6.5 Suspend to Ram

The Suspend to RAM feature is supported on the conga-BAF.

## 6.6 congatec Battery Management Interface

In order to facilitate the development of battery powered mobile systems based on embedded modules, congatec AG has defined an interface for the exchange of data between a CPU module (using an ACPI operating system) and a Smart Battery system. A system developed according to the congatec Battery Management Interface Specification can provide the battery management functions supported by an ACPI capable operating system (e.g. charge state of the battery, information about the battery, alarms/events for certain battery states, ...) without the need for any additional modifications to the system BIOS.

The conga-BAF BIOS fully supports this interface. For more information about this subject visit the congatec website and view the following documents:

- congatec Battery Management Interface Specification
- Battery System Design Guide
- conga-SBM<sup>2</sup>C User's Guide

## 7 conga Tech Notes

---

The conga-BAF has some technological features that require additional explanation. The following section will give the reader a better understanding of some of these features. This information will also help to gain a better understanding of the information found in the System Resources section of this user's guide as well as some of the setup nodes found in the BIOS Setup Program description section.

### 7.1 AHCI

The AMD A55E FCH provides hardware support for Advanced Host Controller Interface (AHCI), a programming interface for SATA host controllers. Platforms supporting AHCI may take advantage of performance features such as no master/slave designation for SATA devices (each device is treated as a master) and hardware-assisted native command queuing. AHCI also provides usability enhancements such as Hot-Plug.

### 7.2 RAID

The industry-leading RAID capability provides high performance RAID 0, 1, 5, and 10 functionality on the 4 SATA ports of the conga-BAF. Software components include an Option ROM for pre-boot configuration and boot functionality, a Microsoft\* Windows\* compatible driver, and a user interface for configuration and management of the RAID capability of the AMD A55E FCH.

For more information about RAID support on the conga-BAF refer to application note AN15\_Configure\_RAID\_System.pdf, which can be found on the congatec AG website at [www.congatec.com](http://www.congatec.com).

### 7.3 Native vs. Compatible IDE mode

#### 7.3.1 Compatible Mode

When operating in compatible mode, the SATA controllers need two legacy IRQs (14 and 15) and are unable to share these IRQs with other devices. This is a result of the fact the SATA controllers emulate the primary and secondary legacy IDE controllers.

#### 7.3.2 Native Mode

Native mode allows the SATA controllers to operate as true PCI devices and therefore do not need dedicated legacy resources, which means they can be configured anywhere within the system. When either SATA controller 1 or 2 runs in native mode it only requires one PCI interrupt for both channels and also has the ability to share this interrupt with other devices in the system. Setting "Native IDE" mode in the BIOS setup



program will automatically enable Native mode. See section 10.4.10 for more information about this. Running in native mode frees up interrupt resources (IRQs 14 and 15) and decreases the chance that there may be a shortage of interrupts when installing devices.

**Note**

*If your operating system supports native mode then congatec AG recommends you enable it.*

## 7.4 Thermal Management

ACPI is responsible for allowing the operating system to play an important part in the system's thermal management. This results in the operating system having the ability to take control of the operating environment by implementing cooling decisions according to the demands put on the CPU by the application.

The conga-BAF ACPI thermal solution offers three different cooling policies.

- **Passive Cooling**

When the temperature in the thermal zone must be reduced, the operating system can decrease the power consumption of the processor by throttling the processor clock. One of the advantages of this cooling policy is that passive cooling devices (in this case the processor) do not produce any noise. Use the "passive cooling trip point" setup node in the BIOS setup program to determine the temperature threshold that the operating system will use to start or stop the passive cooling procedure.

- **Active Cooling**

During this cooling policy the operating system is turning the fan on/off. Although active cooling devices consume power and produce noise, they also have the ability to cool the thermal zone without having to reduce the overall system performance. Use the "active cooling trip point" setup node in the BIOS setup program to determine the temperature threshold that the operating system will use to start the active cooling device. It is stopped again when the temperature goes below the threshold (5°C hysteresis).

- **Critical Trip Point**

If the temperature in the thermal zone reaches a critical point then the operating system will perform a system shut down in an orderly fashion in order to ensure that there is no damage done to the system as result of high temperatures. Use the "critical trip point" setup node in the BIOS setup program to determine the temperature threshold that the operating system will use to shut down the system.

**Note**

*The end user must determine the cooling preferences for the system by using the setup nodes in the BIOS setup program to establish the appropriate trip points.*

If passive cooling is activated and the processor temperature is above the trip point the processor clock is throttled. See section 12 of the ACPI Specification 2.0 C for more information about passive cooling.

## 7.5 ACPI Suspend Modes and Resume Events

conga-BAF supports S3 (STR= Suspend to RAM). For more information about S3 wake events see section 10.4.4 “ACPI Configuration Submenu”.

S4 (Suspend to Disk) is not supported by the BIOS (S4\_BIOS) but it is supported by the following operating systems (S4\_OS= Hibernate):

- Windows 7, Windows Vista, Linux, Windows XP and Windows 2K

This table lists the “Wake Events” that resume the system from S3 unless otherwise stated in the “Conditions/Remarks” column:

Wake Event	Conditions/Remarks
Power Button	Wakes unconditionally from S3-S5.
Onboard LAN Event	Device driver must be configured for Wake On LAN support.
PCI Express WAKE#	Wakes unconditionally from S3-S5.
PME#	Activate the wake up capabilities of a PCI device using Windows Device Manager configuration options for this device OR set Resume On PME# to Enabled in the Power setup menu.
USB Mouse/Keyboard Event	<p>When Standby mode is set to S3, the following must be done for a USB Mouse/Keyboard Event to be used as a Wake Event. USB Hardware must be powered by standby power source.</p> <p>Set USB Device Wakeup from S3/S4 to ENABLED in the ACPI setup menu (if setup node is available in BIOS setup program).</p> <p>Under Windows XP add following registry entries:            Add this key:            HKEY_LOCAL_MACHINE\SYSTEM\CurrentControlSet\Services\usb            Under this key add the following value:            “USBBIOSx”=DWORD:00000000  <i>Note that Windows XP disables USB wakeup from S3, so this entry has to be added to re-enable it.</i></p> <p>Configure USB keyboard/mouse to be able to wake up the system:            In Device Manager look for the keyboard/mouse devices. Go to the Power Management tab and check ‘Allow this device to bring the computer out of standby’.  <i>Note: When the standby state is set to S3 in the ACPI setup menu, the power management tab for USB keyboard /mouse devices only becomes available after adding the above registry entry and rebooting to allow the registry changes to take affect.</i></p>
RTC Alarm	Activate and configure Resume On RTC Alarm in the Power setup menu. Only available in S5.
Watchdog Power Button Event	Wakes unconditionally from S3-S5.



*The above list has been verified using a Windows XP SP3 ACPI enabled installation.*

## 7.6 HDMI/DisplayPort (DP) Audio Support

In order to support HDMI/DP audio, the system must be configured as follows:

- BIOS default settings (HDA Controller ENABLED, HDMI/DP Audio Support ENABLED)
- Installation of AMD chipset drivers include HDMI/DP audio support
- Installation of Realtek HDA codec driver

HDMI/DP audio and native HDA audio can only work one at a time, not both at the same time. The desired audio output must be selected in the audio device driver and/or OS setting.

congatec has validated the HDMI/DP audio functionality within Windows XP SP3 by using the following test procedures and settings.

Play wma/mp3 (video/audio) file with Microsoft Windows media player:

- Audio functions on one output only (either HDMI/DP or HDA):
- Connect headphones to HDMI/DP monitor -> validate that this is functioning.
- Next step (while audio is still present) connect another speaker to the native audio output of the conga-EAF -> validate that no audio is present.
- Change the default “Sound Playback device” in the “Sound and Audio Device Properties” menu (see below) to “Realtek HD Audio output”.



After this change, the audio is no longer present in the headphones connected to the HDMI/DP monitor. The audio is now present on the native audio output of the conga-BAF.

## 8 Signal Descriptions and Pinout Tables

The following section describes the signals found on COM Express™ Type II connectors used for congatec AG modules. The pinout of the modules complies with COM Express Type 2 Rev. 1.0 and have the ability to be optionally compliant with COM Express Type 2 Rev. 2.0.

Table 2 describes the terminology used in this section for the Signal Description tables. The PU/PD column indicates if a COM Express™ module pull-up or pull-down resistor has been used, if the field entry area in this column for the signal is empty, then no pull-up or pull-down resistor has been implemented by congatec.

The “#” symbol at the end of the signal name indicates that the active or asserted state occurs when the signal is at a low voltage level. When “#” is not present, the signal is asserted when at a high voltage level.



### Note

*The Signal Description tables do not list internal pull-ups or pull-downs implemented by the chip vendors, only pull-ups or pull-downs implemented by congatec are listed. For information about the internal pull-ups or pull-downs implemented by the chip vendors, refer to the respective chip’s datasheet.*

**Table 2 Signal Tables Terminology Descriptions**

Term	Description
PU	congatec implemented pull-up resistor
PD	congatec implemented pull-down resistor
I/O 3.3V	Bi-directional signal 3.3V tolerant
I/O 5V	Bi-directional signal 5V tolerant
I 3.3V	Input 3.3V tolerant
I 5V	Input 5V tolerant
I/O 3.3VSB	Input 3.3V tolerant active in standby state
O 3.3V	Output 3.3V signal level
O 5V	Output 5V signal level
OD	Open drain output
P	Power Input/Output
DDC	Display Data Channel
PCIe	In compliance with PCI Express Base Specification, Revision 2.0
PEG	PCI Express Graphics
SATA	In compliance with Serial ATA specification, Revision 2.6
REF	Reference voltage output. May be sourced from a module power plane.
PDS	Pull-down strap. A module output pin that is either tied to GND or is not connected. Used to signal module capabilities (pinout type) to the Carrier Board.

## 8.1 A-B Connector Signal Descriptions

**Table 3 High Definition Audio Signals Descriptions**

Signal	Pin #	Description	I/O	PU/PD	Comment
AC/HDA_RST#	A30	<b>High Definition Audio Reset:</b> This signal is the master hardware reset to external codec(s).	O 3.3VSB		AC'97 codecs are not supported.
AC/HDA_SYNC	A29	<b>High Definition Audio Sync:</b> This signal is a 48 kHz fixed rate sample sync to the codec(s). It is also used to encode the stream number.	O 3.3VSB		AC'97 codecs are not supported.
AC/HDA_BITCLK	A32	<b>High Definition Audio Bit Clock Output:</b> This signal is a 24.000MHz serial data clock generated by the High Definition Audio controller.	O 3.3VSB		AC'97 codecs are not supported.
AC/HDA_SDOUT	A33	<b>High Definition Audio Serial Data Out:</b> This signal is the serial TDM data output to the codec(s). This serial output is double-pumped for a bit rate of 48 Mb/s for High Definition Audio.	O 3.3VSB	PD 10k	AC'97 codecs are not supported. AC/HDA_SDOUT is a boot strap signal (see note below)
AC/HDA_SDIN[2:0]	B28- B30	<b>High Definition Audio Serial Data In [0]:</b> These signals are serial TDM data inputs from the three codecs. The serial input is single-pumped for a bit rate of 24 Mb/s for High Definition Audio.	I 3.3VSB		AC'97 codecs are not supported.



### Note

*Some signals have special functionality during the reset process. They may bootstrap some basic important functions of the module.*

*For more information refer to section 8.5 of this user's guide.*

**Table 4 Gigabit Ethernet Signal Descriptions**

Gigabit Ethernet	Pin #	Description	I/O	PU/PD	Comment				
GBE0_MDI0+	A13	Gigabit Ethernet Controller 0: Media Dependent Interface Differential Pairs 0, 1, 2, 3. The MDI can operate in 1000, 100, and 10Mbit/sec modes. Some pairs are unused in some modes according to the following:	I/O Analog		Twisted pair signals for external transformer.				
GBE0_MDI0-	A12								
GBE0_MDI1+	A10					1000	100	10	
GBE0_MDI1-	A9								
GBE0_MDI2+	A7					MDI[0]+/-	B1_DA+/-	TX+/-	TX+/-
GBE0_MDI2-	A6					MDI[1]+/-	B1_DB+/-	RX+/-	RX+/-
GBE0_MDI3+	A3					MDI[2]+/-	B1_DC+/-		
GBE0_MDI3-	A2					MDI[3]+/-	B1_DD+/-		
GBE0_ACT#	B2	Gigabit Ethernet Controller 0 activity indicator, active low.	O 3.3VSB		See note below				
GBE0_LINK#	A8	Gigabit Ethernet Controller 0 link indicator, active low.	O 3.3VSB		See note below				
GBE0_LINK100#	A4	Gigabit Ethernet Controller 0 100Mbit/sec link indicator, active low.	O 3.3VSB		See note below				
GBE0_LINK1000#	A5	Gigabit Ethernet Controller 0 1000Mbit/sec link indicator, active low.	O 3.3VSB		See note below				
GBE0_CTREF	A14	Reference voltage for Carrier Board Ethernet channel 0 magnetics center tap. The reference voltage is determined by the requirements of the module PHY and may be as low as 0V and as high as 3.3V. The reference voltage output shall be current limited on the module. In the case in which the reference is shorted to ground, the current shall be limited to 250mA or less.			Not connected				

 **Note**

The GBE0\_LINK# output is only active during a 100Mbit or 1Gbit connection, it is not active during a 10Mbit connection. This is a limitation of RTL8111E controller since it only has 3 LED outputs, ACT#, LINK100# and LINK1000#. The GBE0\_LINK# signal is a logic AND of the LINK100# and LINK1000# signals on the conga-BAF module.

The figure below shows an example of the RJ45 connector with LEDs on conga-CEVAL evaluation carrier board.

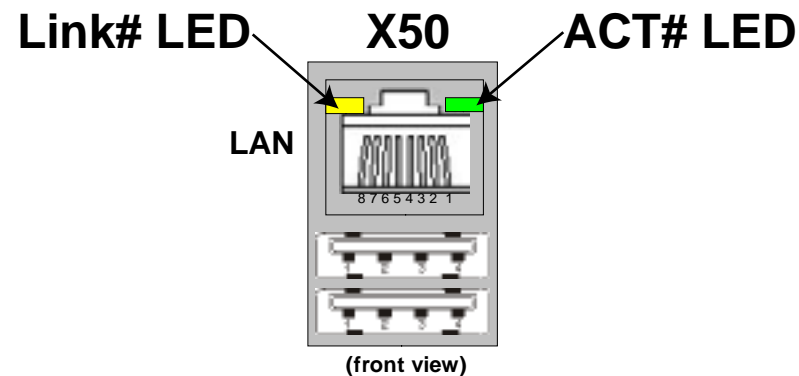

**Table 5 Serial ATA Signal Descriptions**

Signal	Pin #	Description	I/O	PU/PD	Comment
SATA0_RX+ SATA0_RX-	A19 A20	Serial ATA channel 0, Receive Input differential pair.	I SATA		Supports Serial ATA specification, Revision 2.6
SATA0_TX+ SATA0_TX-	A16 A17	Serial ATA channel 0, Transmit Output differential pair.	O SATA		Supports Serial ATA specification, Revision 2.6
SATA1_RX+ SATA1_RX-	B19 B20	Serial ATA channel 1, Receive Input differential pair.	I SATA		Supports Serial ATA specification, Revision 2.6
SATA1_TX+ SATA1_TX-	B16 B17	Serial ATA channel 1, Transmit Output differential pair.	O SATA		Supports Serial ATA specification, Revision 2.6
SATA2_RX+ SATA2_RX-	A25 A26	Serial ATA channel 2, Receive Input differential pair.	I SATA		Supports Serial ATA specification, Revision 2.6
SATA2_TX+ SATA2_TX-	A22 A23	Serial ATA channel 2, Transmit Output differential pair.	O SATA		Supports Serial ATA specification, Revision 2.6
SATA3_RX+ SATA3_RX-	B25 B26	Serial ATA channel 3, Receive Input differential pair.	I SATA		Supports Serial ATA specification, Revision 2.6.
SATA3_TX+ SATA3_TX-	B22 B23	Serial ATA channel 3, Transmit Output differential pair.	O SATA		Supports Serial ATA specification, Revision 2.6.
(S)ATA_ACT#	A28	ATA (parallel and serial) or SAS activity indicator, active low.	O 3.3V		

**Table 6 PCI Express Signal Descriptions (general purpose)**

Signal	Pin #	Description	I/O	PU/PD	Comment
PCIE_RX0+ PCIE_RX0-	B68 B69	PCI Express channel 0, Receive Input differential pair.	I PCIE		Supports PCI Express Base Specification, Revision 2.0
PCIE_TX0+ PCIE_TX0-	A68 A69	PCI Express channel 0, Transmit Output differential pair.	O PCIE		Supports PCI Express Base Specification, Revision 2.0
PCIE_RX1+ PCIE_RX1-	B64 B65	PCI Express channel 1, Receive Input differential pair.	I PCIE		Supports PCI Express Base Specification, Revision 2.0
PCIE_TX1+ PCIE_TX1-	A64 A65	PCI Express channel 1, Transmit Output differential pair.	O PCIE		Supports PCI Express Base Specification, Revision 2.0
PCIE_RX2+ PCIE_RX2-	B61 B62	PCI Express channel 2, Receive Input differential pair.	I PCIE		Supports PCI Express Base Specification, Revision 2.0
PCIE_TX2+ PCIE_TX2-	A61 A62	PCI Express channel 2, Transmit Output differential pair.	O PCIE		Supports PCI Express Base Specification, Revision 2.0
PCIE_RX3+ PCIE_RX3-	B58 B59	PCI Express channel 3, Receive Input differential pair.	I PCIE		Supports PCI Express Base Specification, Revision 2.0
PCIE_TX3+ PCIE_TX3-	A58 A59	PCI Express channel 3, Transmit Output differential pair.	O PCIE		Supports PCI Express Base Specification, Revision 2.0
PCIE_RX4+ PCIE_RX4-	B55 B56	PCI Express channel 4, Receive Input differential pair.	I PCIE		Supports PCI Express Base Specification, Revision 2.0
PCIE_TX4+ PCIE_TX4-	A55 A56	PCI Express channel 4, Transmit Output differential pair.	O PCIE		Supports PCI Express Base Specification, Revision 2.0



PCIE_RX5+ PCIE_RX5-	B52 B53	PCI Express channel 5, Receive Input differential pair.	I PCIE		Supports PCI Express Base Specification, Revision 2.0
PCIE_TX5+ PCIE_TX5-	A52 A53	PCI Express channel 5, Transmit Output differential pair.	O PCIE		Supports PCI Express Base Specification, Revision 2.0
PCIE_CLK_REF+ PCIE_CLK_REF-	A88 A89	PCI Express Reference Clock output for all PCI Express and PCI Express Graphics Lanes.	O PCIE		

**Table 7 ExpressCard Support Pins Descriptions**

Signal	Pin #	Description	I/O	PU/PD	Comment
EXCD0_CPPE# EXCD1_CPPE#	A49 B48	ExpressCard capable card request.	I 3.3VSB		
EXCD0_PERST# EXCD1_PERST#	A48 B47	ExpressCard Reset	O 3.3VSB		

**Table 8 LPC Signal Descriptions**

Signal	Pin #	Description	I/O	PU/PD	Comment
LPC_AD[0:3]	B4-B7	LPC multiplexed address, command and data bus	I/O 3.3V		
LPC_FRAME#	B3	LPC frame indicates the start of an LPC cycle	O 3.3V		
LPC_DRQ[0:1]#	B8-B9	LPC serial DMA request	I 3.3V		
LPC_SERIRQ	A50	LPC serial interrupt	I/O 3.3V		
LPC_CLK	B10	LPC clock output - 33MHz nominal	O 3.3V	PD 10k	LPC_CLK is a boot strap signal (see note below).

**Note**

*Some signals have special functionality during the reset process. They may bootstrap some basic important functions of the module.*

*For more information refer to section 8.5 of this user's guide.*

**Table 9 USB Signal Descriptions**

Signal	Pin #	Description	I/O	PU/PD	Comment
USB0+	A46	USB Port 0, data + or D+	I/O		USB 2.0 compliant. Backwards compatible to USB 1.1
USB0-	A45	USB Port 0, data - or D-	I/O		USB 2.0 compliant. Backwards compatible to USB 1.1
USB1+	B46	USB Port 1, data + or D+	I/O		USB 2.0 compliant. Backwards compatible to USB 1.1
USB1-	B45	USB Port 1, data - or D-	I/O		USB 2.0 compliant. Backwards compatible to USB 1.1
USB2+	A43	USB Port 2, data + or D+	I/O		USB 2.0 compliant. Backwards compatible to USB 1.1
USB2-	A42	USB Port 2, data - or D-	I/O		USB 2.0 compliant. Backwards compatible to USB 1.1
USB3+	B43	USB Port 3, data + or D+	I/O		USB 2.0 compliant. Backwards compatible to USB 1.1
USB3-	B42	USB Port 3, data - or D-	I/O		USB 2.0 compliant. Backwards compatible to USB 1.1
USB4+	A40	USB Port 4, data + or D+	I/O		USB 2.0 compliant. Backwards compatible to USB 1.1
USB4-	A39	USB Port 4, data - or D-	I/O		USB 2.0 compliant. Backwards compatible to USB 1.1
USB5+	B40	USB Port 5, data + or D+	I/O		USB 2.0 compliant. Backwards compatible to USB 1.1
USB5-	B39	USB Port 5, data - or D-	I/O		USB 2.0 compliant. Backwards compatible to USB 1.1
USB6+	A37	USB Port 6, data + or D+	I/O		USB 2.0 compliant. Backwards compatible to USB 1.1
USB6-	A36	USB Port 6, data - or D-	I/O		USB 2.0 compliant. Backwards compatible to USB 1.1
USB7+	B37	USB Port 7, data + or D+	I/O		USB 2.0 compliant. Backwards compatible to USB 1.1
USB7-	B36	USB Port 7, data - or D-	I/O		USB 2.0 compliant. Backwards compatible to USB 1.1
USB_0_1_OC#	B44	USB over-current sense, USB ports 0 and 1. A pull-up for this line shall be present on the module. An open drain driver from a USB current monitor on the carrier board may drive this line low.	I 3.3VSB	PU 10k	Do not pull this line high on the carrier board.
USB_2_3_OC#	A44	USB over-current sense, USB ports 2 and 3. A pull-up for this line shall be present on the module. An open drain driver from a USB current monitor on the carrier board may drive this line low. .	I 3.3VSB	PU 10k	Do not pull this line high on the carrier board.
USB_4_5_OC#	B38	USB over-current sense, USB ports 4 and 5. A pull-up for this line shall be present on the module. An open drain driver from a USB current monitor on the carrier board may drive this line low.	I 3.3VSB	PU 10k	Do not pull this line high on the carrier board.
USB_6_7_OC#	A38	USB over-current sense, USB ports 6 and 7. A pull-up for this line shall be present on the module. An open drain driver from a USB current monitor on the carrier board may drive this line low.	I 3.3VSB	PU 10k	Do not pull this line high on the carrier board.

**Table 10 CRT Signal Descriptions**

Signal	Pin #	Description	I/O	PU/PD	Comment
VGA_RED	B89	Red for monitor. Analog DAC output, designed to drive a 37.5-Ohm equivalent load.	O Analog		Analog output
VGA_GRN	B91	Green for monitor. Analog DAC output, designed to drive a 37.5-Ohm equivalent load.	O Analog		Analog output
VGA_BLU	B92	Blue for monitor. Analog DAC output, designed to drive a 37.5-Ohm equivalent load.	O Analog		Analog output
VGA_HSYNC	B93	Horizontal sync output to VGA monitor	O 3.3V		
VGA_VSYNC	B94	Vertical sync output to VGA monitor	O 3.3V		
VGA_I2C_CK	B95	DDC clock line (I <sup>2</sup> C port dedicated to identify VGA monitor capabilities)	O 3.3V	PU 4.7k	
VGA_I2C_DAT	B96	DDC data line.	I/OD 3.3V	PU 4.7k	

**Table 11 LVDS Signal Descriptions**

Signal	Pin #	Description	I/O	PU/PD	Comment
LVDS_A0+	A71	LVDS Channel A differential pairs	O LVDS		
LVDS_A0-	A72				
LVDS_A1+	A73				
LVDS_A1-	A74				
LVDS_A2+	A75				
LVDS_A2-	A76				
LVDS_A3+	A78				
LVDS_A3-	A79				
LVDS_A_CK+	A81	LVDS Channel A differential clock	O LVDS		
LVDS_A_CK-	A82				
LVDS_B0+	B71	LVDS Channel B differential pairs	O LVDS		
LVDS_B0-	B72				
LVDS_B1+	B73				
LVDS_B1-	B74				
LVDS_B2+	B75				
LVDS_B2-	B76				
LVDS_B3+	B77				
LVDS_B3-	B78				
LVDS_B_CK+	B81	LVDS Channel B differential clock	O LVDS		
LVDS_B_CK-	B82				
LVDS_VDD_EN	A77	LVDS panel power enable	O 3.3V	PD 10k	
LVDS_BKLT_EN	B79	LVDS panel backlight enable	O 3.3V	PD 10k	
LVDS_BKLT_CTRL	B83	LVDS panel backlight brightness control	O 3.3V		
LVDS_I2C_CK	A83	DDC lines used for flat panel detection and control.	O 3.3V	PU 2k2	
LVDS_I2C_DAT	A84	DDC lines used for flat panel detection and control.	I/OD 3.3V	PU 2k2	

**Table 12 SPI BIOS Flash Interface Signal Descriptions**

Signal	Pin #	Description	I/O	PU/PD	Comment
SPI_CS#	B97	Chip select for Carrier Board SPI BIOS Flash.	O 3.3VSB	PU 10k	
SPI_MISO	A92	Data in to module from carrier board SPI BIOS flash.	I 3.3VSB		
SPI_MOSI	A95	Data out from module to carrier board SPI BIOS flash.	O 3.3VSB		
SPI_CLK	A94	Clock from module to carrier board SPI BIOS flash.	O 3.3VSB		
SPI_POWER	A91	Power source for carrier board SPI BIOS flash. SPI_POWER shall be used to power SPI BIOS flash on the carrier only.	+ 3.3VSB		
BIOS_DIS0#	A34	Selection strap to determine the BIOS boot device.	I 3.3VSB	PU 10k	Carrier shall pull to GND or leave no-connect.
BIOS_DIS1#	B88	Selection strap to determine the BIOS boot device.	I 3.3VSB	PU 10k	Carrier shall pull to GND or leave no-connect

 **Note**

External LPC FWH is not supported on conga-BAF, only SPI BIOS Flash. If the conga-CEVAL evaluation carrier board is used in conjunction with the conga-BAF, SPI BIOS Flash can be set by switching OFF BIOS\_DIS1# (dip switch M46 on conga-CEVAL rev. C.0). LED FWH\_ENA (D28 on conga-CEVAL rev. C.0) is ON if module boots from on-module SPI and is OFF if module boots from external SPI. See picture below.

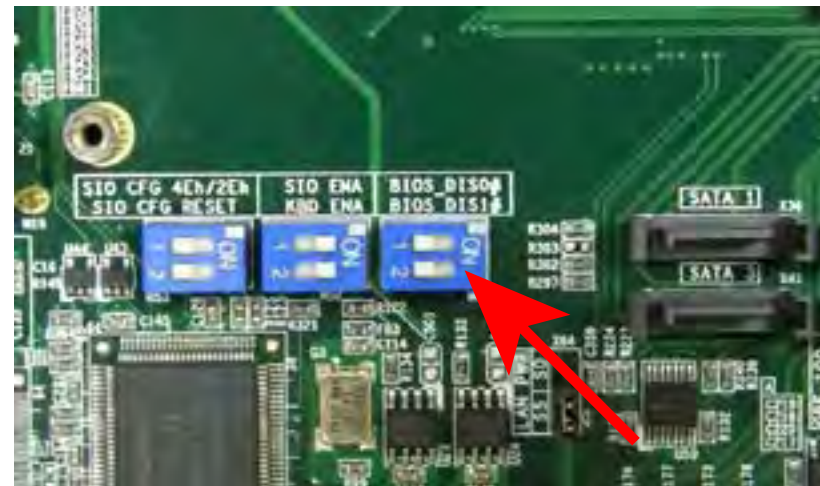

**Table 13 Miscellaneous Signal Descriptions**

Signal	Pin #	Description	I/O	PU/PD	Comment
I2C_CK	B33	General purpose I <sup>2</sup> C port clock output/input	I/OD 3.3VSB	PU 2k2	
I2C_DAT	B34	General purpose I <sup>2</sup> C port data I/O line	I/OD 3.3VSB	PU 2k2	
SPKR	B32	Output for audio enunciator, the "speaker" in PC-AT systems	O 3.3V	PD 10k	
WDT	B27	Output indicating that a watchdog time-out event has occurred.	O 3.3V	PU 10k	
KBD_RST#	A86	Input to module from (optional) external keyboard controller that can force a reset. Pulled high on the module. This is a legacy artifact of the PC-AT.	I 3.3V		
KBD_A20GATE	A87	Input to module from (optional) external keyboard controller that can be used to control the CPU A20 gate line. The A20GATE restricts the memory access to the bottom megabyte and is a legacy artifact of the PC-AT. Pulled low on the module.	I 3.3V		

**Table 14 General Purpose I/O Signal Descriptions**

Signal	Pin #	Description	I/O	PU/PD	Comment
GPO[0]	A93	General purpose output pins.	O 3.3V		
GPO[1]	B54	General purpose output pins.	O 3.3V		
GPO[2]	B57	General purpose output pins.	O 3.3V		
GPO[3]	B63	General purpose output pins.	O 3.3V		
GPI[0]	A54	General purpose input pins. Pulled high internally on the module.	I 3.3V	PU 40k	Pull-up integrated in CGBC
GPI[1]	A63	General purpose input pins. Pulled high internally on the module.	I 3.3V	PU 40k	Pull-up integrated in CGBC
GPI[2]	A67	General purpose input pins. Pulled high internally on the module.	I 3.3V	PU 40k	Pull-up integrated in CGBC
GPI[3]	A85	General purpose input pins. Pulled high internally on the module.	I 3.3V	PU 40k	Pull-up integrated in CGBC

**Table 15 Power and System Management Signal Descriptions**

Signal	Pin #	Description	I/O	PU/PD	Comment
PWRBTN#	B12	Power button to bring system out of S5 (soft off), active on rising edge.	I 3.3VSB	PU 10k	
SYS_RESET#	B49	Reset button input. Active low input. Edge triggered. System is held in hardware reset while this input is low and comes out of reset upon release.	I 3.3VSB	PU 3uA	3uA current to pull-up this input
CB_RESET#	B50	Reset output from module to Carrier Board. Active low. Issued by module chipset and may result from a low SYS_RESET# input, a low PWR_OK input, a VCC_12V power input that falls below the minimum specification, a watchdog timeout, or may be initiated by the module software.	O 3.3VSB		
PWR_OK	B24	Power OK from main power supply. A high value indicates that the power is good.	I 3.3V	PU 10k	
SUS_STAT#	B18	Indicates imminent suspend operation; used to notify LPC devices.	O 3.3VSB	PU 4.7k	
SUS_S3#	A15	Indicates system is in Suspend to RAM state. Active-low output. An inverted copy of SUS_S3# on the carrier board (also known as "PS_ON") may be used to enable the non-standby power on a typical ATX power supply.	O 3.3VSB		
SUS_S4#	A18	Indicates system is in Suspend to Disk state. Active low output.	O 3.3VSB		Not supported, connected to SUS_S5# on the module.
SUS_S5#	A24	Indicates system is in Soft Off state.	O 3.3VSB		
WAKE0#	B66	PCI Express wake up signal.	I 3.3VSB		
WAKE1#	B67	General purpose wake up signal. May be used to implement wake-up on PS/2 keyboard or mouse activity.	I 3.3VSB		
BATLOW#	A27	Battery low input. This signal may be driven low by external circuitry to signal that the system battery is low, or may be used to signal some other external power-management event.	I 3.3VSB		
THRM#	B35	Input from off-module temp sensor indicating an over-temp situation.	I 3.3V	PU 10k	
THERMTRIP#	A35	Active low output indicating that the CPU has entered thermal shutdown.	O 3.3V	PU 1k	
SMB_CK	B13	System Management Bus bidirectional clock line. Power sourced through 5V standby rail and main power rails.	I/O 3.3VSB	PU 2k2	
SMB_DAT#	B14	System Management Bus bidirectional data line. Power sourced through 5V standby rail and main power rails.	I/O 3.3VSB	PU 2k2	
SMB_ALERT#	B15	System Management Bus Alert – active low input can be used to generate an SMI# (System Management Interrupt) or to wake the system. Power sourced through 5V standby rail and main power rails.	I 3.3VSB	PU 10k	

**Table 16 Power and GND Signal Descriptions**

Signal	Pin #	Description	I/O	PU/PD	Comment
VCC_12V	A104-A109 B104-B109	Primary power input: +12V nominal. All available VCC_12V pins on the connector(s) shall be used.	P		
VCC_5V_SBY	B84-B87	Standby power input: +5.0V nominal. If VCC5_SBY is used, all available VCC_5V_SBY pins on the connector(s) shall be used. Only used for standby and suspend functions. May be left unconnected if these functions are not used in the system design.	P		
VCC_RTC	A47	Real-time clock circuit-power input. Nominally +3.0V.	P		
GND	A1, A11, A21, A31, A41, A51, A57, A66, A80, A90, A96, A100, A110, B1, B11, B21 ,B31, B41, B51, B60, B70, B80, B90, B100, B110	Ground - DC power and signal and AC signal return path. All available GND connector pins shall be used and tied to Carrier Board GND plane.	P		

## 8.2 A-B Connector Pinout

**Table 17 Connector A-B Pinout**

Pin	Row A	Pin	Row B	Pin	Row A	Pin	Row B
A1	GND (FIXED)	B1	GND (FIXED)	A56	PCIE_TX4-	B56	PCIE_RX4-
A2	GBE0_MDI3-	B2	GBE0_ACT#	A57	GND	B57	GPO2
A3	GBE0_MDI3+	B3	LPC_FRAME#	A58	PCIE_TX3+	B58	PCIE_RX3+
A4	GBE0_LINK100#	B4	LPC_AD0	A59	PCIE_TX3-	B59	PCIE_RX3-
A5	GBE0_LINK1000#	B5	LPC_AD1	A60	GND (FIXED)	B60	GND (FIXED)
A6	GBE0_MDI2-	B6	LPC_AD2	A61	PCIE_TX2+	B61	PCIE_RX2+
A7	GBE0_MDI2+	B7	LPC_AD3	A62	PCIE_TX2-	B62	PCIE_RX2-
A8	GBE0_LINK#	B8	LPC_DRQ0#	A63	GPI1	B63	GPO3
A9	GBE0_MDI1-	B9	LPC_DRQ1#	A64	PCIE_TX1+	B64	PCIE_RX1+
A10	GBE0_MDI1+	B10	LPC_CLK	A65	PCIE_TX1-	B65	PCIE_RX1-
A11	GND (FIXED)	B11	GND (FIXED)	A66	GND	B66	WAKE0#
A12	GBE0_MDI0-	B12	PWRBTN#	A67	GPI2	B67	WAKE1#
A13	GBE0_MDI0+	B13	SMB_CK	A68	PCIE_TX0+	B68	PCIE_RX0+
A14	GBE0_CTREF (*)	B14	SMB_DAT	A69	PCIE_TX0-	B69	PCIE_RX0-
A15	SUS_S3#	B15	SMB_ALERT#	A70	GND (FIXED)	B70	GND (FIXED)
A16	SATA0_TX+	B16	SATA1_TX+	A71	LVDS_A0+	B71	LVDS_B0+
A17	SATA0_TX-	B17	SATA1_TX-	A72	LVDS_A0-	B72	LVDS_B0-
A18	SUS_S4# (*)	B18	SUS_STAT#	A73	LVDS_A1+	B73	LVDS_B1+
A19	SATA0_RX+	B19	SATA1_RX+	A74	LVDS_A1-	B74	LVDS_B1-
A20	SATA0_RX-	B20	SATA1_RX-	A75	LVDS_A2+	B75	LVDS_B2+
A21	GND (FIXED)	B21	GND (FIXED)	A76	LVDS_A2-	B76	LVDS_B2-
A22	SATA2_TX+	B22	SATA3_TX+	A77	LVDS_VDD_EN	B77	LVDS_B3+
A23	SATA2_TX-	B23	SATA3_TX-	A78	LVDS_A3+	B78	LVDS_B3-
A24	SUS_S5#	B24	PWR_OK	A79	LVDS_A3-	B79	LVDS_BKLT_EN
A25	SATA2_RX+	B25	SATA3_RX+	A80	GND (FIXED)	B80	GND (FIXED)
A26	SATA2_RX-	B26	SATA3_RX-	A81	LVDS_A_CK+	B81	LVDS_B_CK+
A27	BATLOW#	B27	WDT	A82	LVDS_A_CK-	B82	LVDS_B_CK-
A28	(S)ATA_ACT#	B28	AC/HDA_SDIN2	A83	LVDS_I2C_CK	B83	LVDS_BKLT_CTRL
A29	AC/HDA_SYNC	B29	AC/HDA_SDIN1	A84	LVDS_I2C_DAT	B84	VCC_5V_SBY
A30	AC/HDA_RST#	B30	AC/HDA_SDIN0	A85	GPI3	B85	VCC_5V_SBY
A31	GND (FIXED)	B31	GND (FIXED)	A86	KBD_RST#	B86	VCC_5V_SBY
A32	AC/HDA_BITCLK	B32	SPKR	A87	KBD_A20GATE	B87	VCC_5V_SBY
A33	AC/HDA_SDOOUT	B33	I2C_CK	A88	PCIE0_CK_REF+	B88	BIOS_DIS1#
A34	BIOS_DIS0#	B34	I2C_DAT	A89	PCIE0_CK_REF-	B89	VGA_RED
A35	THRMTRIP#	B35	THRM#	A90	GND (FIXED)	B90	GND (FIXED)
A36	USB6-	B36	USB7-	A91	SPI_POWER	B91	VGA_GRN
A37	USB6+	B37	USB7+	A92	SPI_MISO	B92	VGA_BLU



Pin	Row A	Pin	Row B	Pin	Row A	Pin	Row B
A38	USB_6_7_OC#	B38	USB_4_5_OC#	A93	GPO0	B93	VGA_HSYNC
A39	USB4-	B39	USB5-	A94	SPI_CLK	B94	VGA_VSYNC
A40	USB4+	B40	USB5+	A95	SPI_MOSI	B95	VGA_I2C_CK
A41	GND (FIXED)	B41	GND (FIXED)	A96	GND	B96	VGA_I2C_DAT
A42	USB2-	B42	USB3-	A97	TYPE10#	B97	SPI_CS#
A43	USB2+	B43	USB3+	A98	RSVD	B98	RSVD
A44	USB_2_3_OC#	B44	USB_0_1_OC#	A99	RSVD	B99	RSVD
A45	USB0-	B45	USB1-	A100	GND (FIXED)	B100	GND (FIXED)
A46	USB0+	B46	USB1+	A101	RSVD	B101	RSVD
A47	VCC_RTC	B47	EXCD1_PERST#	A102	RSVD	B102	RSVD
A48	EXCD0_PERST#	B48	EXCD1_CPPE#	A103	RSVD	B103	RSVD
A49	EXCD0_CPPE#	B49	SYS_RESET#	A104	VCC_12V	B104	VCC_12V
A50	LPC_SERIRQ	B50	CB_RESET#	A105	VCC_12V	B105	VCC_12V
A51	GND (FIXED)	B51	GND (FIXED)	A106	VCC_12V	B106	VCC_12V
A52	PCIE_TX5+	B52	PCIE_RX5+	A107	VCC_12V	B107	VCC_12V
A53	PCIE_TX5-	B53	PCIE_RX5-	A108	VCC_12V	B108	VCC_12V
A54	GPI0	B54	GPO1	A109	VCC_12V	B109	VCC_12V
A55	PCIE_TX4+	B55	PCIE_RX4+	A110	GND (FIXED)	B110	GND (FIXED)

**Note**

The signals marked with an asterisk symbol (\*) are not supported on the conga-BAF.

## 8.3 C-D Connector Signal Descriptions

**Table 18 PCI Signal Descriptions**

Signal	Pin #	Description	I/O	PU/PD	Comment
PCI_AD[0, 2, 4, 6, 8, 10, 12] PCI_AD[1, 3, 5, 7] PCI_AD[9, 11, 13, 15] PCI_AD14 PCI_AD[16, 18, 20, 22] PCI_AD[17, 19] PCI_AD[21, 23] PCI_AD[24, 26, 28, 30] PCI_AD[25, 27, 29, 31]	C24- C30 D22- D25 D27- D30 D32 D37- D40 C39-C40 C42-C43 D42- D45 C45- C48	PCI bus multiplexed address and data lines	I/O 3.3V		
PCI_C/BE0# PCI_C/BE1# PCI_C/BE2# PCI_C/BE3#	D26 C33 C38 C44	PCI bus byte enable lines, active low	I/O 3.3V		
PCI_DEVSEL#	C36	PCI bus Device Select, active low.	I/O 3.3V		
PCI_FRAME#	D36	PCI bus Frame control line, active low.	I/O 3.3V		
PCI_IRDY#	C37	PCI bus Initiator Ready control line, active low.	I/O 3.3V		
PCI_TRDY#	D35	PCI bus Target Ready control line, active low.	I/O 3.3V		
PCI_STOP#	D34	PCI bus STOP control line, active low, driven by cycle initiator.	I/O 3.3V		
PCI_PAR	D32	PCI bus parity	I/O 3.3V		
PCI_PERR#	C34	Parity Error: An external PCI device drives PERR# when it receives data that has a parity error.	I/O 3.3V		
PCI_REQ0# PCI_REQ1# PCI_REQ2# PCI_REQ3#	C22 C19 C17 D20	PCI bus master request input lines, active low.	I 3.3V		
PCI_GNT0# PCI_GNT1# PCI_GNT2# PCI_GNT3#	C20 C18 C16 D19	PCI bus master grant output lines, active low.	O 3.3V		
PCI_RESET#	C23	PCI Reset output, active low.	O 3.3V		
PCI_LOCK#	C35	PCI Lock control line, active low.	I/O 3.3V		
PCI_SERR#	D33	System Error: SERR# may be pulsed active by any PCI device that detects a system error condition.	I/O 3.3V		
PCI_PME#	C15	PCI Power Management Event: PCI peripherals drive PME# to wake system from low-power states S1-S5.	I 3.3VSB		

Signal	Pin #	Description	I/O	PU/PD	Comment
PCI_CLKRUN#	D48	Bidirectional pin used to support PCI clock run protocol for mobile systems.	I/O 3.3V		
PCI_IRQA#	C49	PCI interrupt request lines.	I 3.3V		
PCI_IRQB#	C50				
PCI_IRQC#	D46				
PCI_IRQD#	D47				
PCI_CLK	D50	PCI 33MHz clock output.	O 3.3V		
PCI_M66EN	D49	Module input signal indicates whether an off-module PCI device is capable of 66MHz operation. Pulled to GND by Carrier Board device or by Slot Card if the devices are NOT capable of 66MHz operation. If the module is not capable of supporting 66MHz PCI operation, this input may be a no-connect on the module. If the module is capable of supporting 66MHz PCI operation, and if this input is held low by the Carrier Board, the module PCI interface shall operate at 33MHz.	I 3.3V		Not connected

**Note**

*The PCI interface is specified to be +5V tolerant, with +3.3V signaling.*

**Table 19 IDE Signal Descriptions**

Signal	Pin #	Description	I/O	PU/PD	Comment
IDE_D0	D7	Bidirectional data to / from IDE device.	I/O 3.3V	IDE_D7 PD 10k	Only IDE_D7 has a pull-down
IDE_D1	C10				
IDE_D2	C8				
IDE_D3	C4				
IDE_D4	D6				
IDE_D5	D2				
IDE_D6	C3				
IDE_D7	C2				
IDE_D8	C6				
IDE_D9	C7				
IDE_D10	D3				
IDE_D11	D4				
IDE_D12	D5				
IDE_D13	C9				
IDE_D14	C12				
IDE_D15	C5				
IDE_A[0.2]	D13-D15	Address lines to IDE device.	O 3.3V		
IDE_IOW#	D9	I/O write line to IDE device. Data latched on trailing (rising) edge.	O 3.3V		
IDE_IOR#	C14	I/O read line to IDE device.	O 3.3V		
IDE_REQ	D8	IDE Device DMA Request. It is asserted by the IDE device to request a data transfer.	I 3.3V	PD 5k6	
IDE_ACK#	D10	IDE Device DMA Acknowledge.	O 3.3V		
IDE_CS1#	D16	IDE Device Chip Select for 1F0h to 1FFh range.	O 3.3V		
IDE_CS3#	D17	IDE Device Chip Select for 3F0h to 3FFh range.	O 3.3V		
IDE_IORDY	C13	IDE device I/O ready input. Pulled low by the IDE device to extend the cycle.	I 3.3V	PU 4k7	
IDE_RESET#	D18	Reset output to IDE device, active low.	O 3.3V		
IDE_IRQ	D12	Interrupt request from IDE device.	I 3.3V	PD 10k	
IDE_CBLID#	D77	Input from off-module hardware indicating the type of IDE cable being used. High indicates a 40-pin cable used for legacy IDE modes. Low indicates that an 80-pin cable with interleaved grounds is used. Such a cable is required for Ultra-DMA 66, 100 and 133 modes.	I 3.3V	PD 10k	

**Note**

*The IDE interface is specified to be +5V tolerant, with +3.3V signaling.*

**Table 20 PCI Express Signal Descriptions (x16 Graphics)**

Signal	Pin #	Description	I/O	PU/PD	Comment
PEG_RX0+	C52	PCI Express Graphics Receive Input differential pairs. Some of these lines are multiplexed with the DisplayPort and HDMI signals.	I PCIE		PCI Express Graphics (PEG) is not supported on the conga-BAF (see note below).
PEG_RX0-	C53				
PEG_RX1+	C55				
PEG_RX1-	C56				
PEG_RX2+	C58				
PEG_RX2-	C59				
PEG_RX3+	C61				
PEG_RX3-	C62				
PEG_RX4+	C65				
PEG_RX4-	C66				
PEG_RX5+	C68				
PEG_RX5-	C69				
PEG_RX6+	C71				
PEG_RX6-	C72				
PEG_RX7+	C74				
PEG_RX7-	C75				
PEG_RX8+	C78				
PEG_RX8-	C79				
PEG_RX9+	C81				
PEG_RX9-	C82				
PEG_RX10+	C85				
PEG_RX10-	C86				
PEG_RX11+	C88				
PEG_RX11-	C89				
PEG_RX12+	C91				
PEG_RX12-	C92				
PEG_RX13+	C94				
PEG_RX13-	C95				
PEG_RX14+	C98				
PEG_RX14-	C99				
PEG_RX15+	C101				
PEG_RX15-	C102				

Signal	Pin #	Description	I/O	PU/PD	Comment
PEG_TX0+	D52	PCI Express Graphics Transmit Output differential pairs. Some of these lines are multiplexed with Some of these lines are multiplexed with the DisplayPort and HDMI signals.	O PCIE		Not supported
PEG_TX0-	D53				
PEG_TX1+	D55				
PEG_TX1-	D56				
PEG_TX2+	D58				
PEG_TX2-	D59				
PEG_TX3+	D61				
PEG_TX3-	D62				
PEG_TX4+	D65				
PEG_TX4-	D66				
PEG_TX5+	D68				
PEG_TX5-	D69				
PEG_TX6+	D71				
PEG_TX6-	D72				
PEG_TX7+	D74				
PEG_TX7-	D75				
PEG_TX8+	D78				
PEG_TX8-	D79				
PEG_TX9+	D81				
PEG_TX9-	D82				
PEG_TX10+	D85				
PEG_TX10-	D86				
PEG_TX11+	D88				
PEG_TX11-	D89				
PEG_TX12+	D91				
PEG_TX12-	D92				
PEG_TX13+	D94				
PEG_TX13-	D95				
PEG_TX14+	D98				
PEG_TX14-	D99				
PEG_TX15+	D101				
PEG_TX15-	D102				
PEG_LANE_RV#	D54	PCI Express Graphics lane reversal input strap. Pull low on the carrier board to reverse lane order.	I 1.05V		Not supported
PEG_ENABLE#	D97	Strap to enable PCI Express x16 external graphics interface.	I 3.3V		Not supported

**Note**

*The PCI Express Graphics (PEG) signals are multiplexed with HDMI and DisplayPort (DP). The signals for these interfaces are routed to the PEG interface of the COM Express connector. Refer to the HDMI and DisplayPort signal description tables in this section for information about the signals routed to the PEG interface of the COM Express connector.*

**Table 21 HDMI Signal Descriptions**

Signal	Pin #	Description	I/O	PU/PD	Comment
TMDS_B_CLK + TMDS_B_CLK -	D61 D62	HDMI Port B Clock output differential pair. Multiplexed with PEG_TX[3]+ and PEG_TX[3]- pair.	O PCIE		These signals are available when the "Display Channel 1 Output" setup node is set to HDMI B in the BIOS Setup Program.
TMDS_B_DATA0+ TMDS_B_DATA0-	D58 D59	HDMI Port B Data0 output differential pair. Multiplexed with PEG_TX[2]+ and PEG_TX[2]-.	O PCIE		These signals are available when the "Display Channel 1 Output" setup node is set to HDMI B in the BIOS Setup Program.
TMDS_B_DATA1+ TMDS_B_DATA1-	D55 D56	HDMI Port B Data1 output differential pair. Multiplexed with PEG_TX[1]+ and PEG_TX[1]-.	O PCIE		These signals are available when the "Display Channel 1 Output" setup node is set to HDMI B in the BIOS Setup Program.
TMDS_B_DATA2+ TMDS_B_DATA2-	D52 D53	HDMI Port B Data2 output differential pair. Multiplexed with PEG_TX[0]+ and PEG_TX[0]-.	O PCIE		These signals are available when the "Display Channel 1 Output" setup node is set to HDMI B in the BIOS Setup Program.
TMDS_B_HPD#	C61	HDMI Port B Hot-plug detect. Multiplexed with PEG_RX[3]+.	I PCIE	PU 2k7 to 0.9V	These signals are available when the "Display Channel 1 Output" setup node is set to HDMI B in the BIOS Setup Program.
DPB_AUX+ DPB_AUX-	C58 C59	Used as HDMI port B Control Clock Used as HDMI port B Control Data Multiplexed with PEG_RX[2]+ and PEG_RX[2]- pair.	I/O 3.3V		When the "Display Channel 1 Output" setup node is set to HDMI B in the BIOS Setup Program, DPB_AUX+ is used as HDMI port B Control Clock and DPB_AUX- is used as HDMI port B Control Data.
DDPB_CTRLCLK	D73	HDMI port B Control Clock	I/OD 3.3V		Not connected
DDPB_CTRLDATA	C73	HDMI port B Control Data	I/OD 3.3V		Not connected
TMDS_C_CLK + TMDS_C_CLK -	D74 D75	HDMI Port C Clock output differential pair. Multiplexed with PEG_TX[7]+ and PEG_TX[7]- pair.	O PCIE		These signals are available when the "Display Channel 0 Output" setup node is set to HDMI C in the BIOS Setup Program. Not connected if LVDS feature is available on conga-BAF.
TMDS_C_DATA0+ TMDS_C_DATA0-	D71 D72	HDMI Port C Data0 output differential pair. Multiplexed with PEG_TX[6]+ and PEG_TX[6]-.	O PCIE		These signals are available when the "Display Channel 0 Output" setup node is set to HDMI C in the BIOS Setup Program. Not connected if LVDS feature is available on conga-BAF.
TMDS_C_DATA1+ TMDS_C_DATA1-	D68 D69	HDMI Port C Data1 output differential pair. Multiplexed with PEG_TX[5]+ and PEG_TX[5]-.	O PCIE		These signals are available when the "Display Channel 0 Output" setup node is set to HDMI C in the BIOS Setup Program. Not connected if LVDS feature is available on conga-BAF.
TMDS_C_DATA2+ TMDS_C_DATA2-	D65 D66	HDMI Port C Data2 output differential pair. Multiplexed with PEG_TX[4]+ and PEG_TX[4]-.	O PCIE		These signals are available when the "Display Channel 0 Output" setup node is set to HDMI C in the BIOS Setup Program. Not connected if LVDS feature is available on conga-BAF.

Signal	Pin #	Description	I/O	PU/PD	Comment
TMD5_C_HPDI#	C74	HDMI Port C Hot-plug detect. Multiplexed with PEG_RX[7]+.	I PCIE	PU 2k7 to 0.9V	These signals are available when the "Display Channel 0 Output" setup node is set to HDMI C in the BIOS Setup Program. Not connected if LVDS feature is available on conga-BAF.
DPC_AUX+ DPC_AUX-	C71 C72	Used as HDMI port C Control Clock Used as HDMI port C Control Data Multiplexed with PEG_RX[6]+ and PEG_RX[6]- pair.	I/O 3.3V		When the "Display Channel 0 Output" setup node is set to HDMI C in the BIOS Setup Program, DPC_AUX+ is used as HDMI port C Control Clock and DPC_AUX- is used as HDMI port C Control Data. Not connected if LVDS feature is available on conga-BAF.
DDPC_CTRLCLK	D63	HDMI port C Control Clock Uses COM Express Type 2 reserved (RSVD) pin D63	I/OD 3.3V		Not connected
DDPC_CTRLDATA	D64	HDMI port C Control Data Uses COM Express Type 2 reserved (RSVD) pin D64	I/OD 3.3V		Not connected

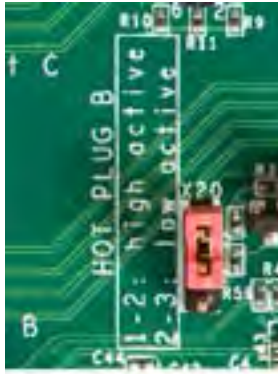

**Table 22 DisplayPort (DP) Signal Descriptions**

Signal	Pin #	Description	I/O	PU/PD	Comment
DPB_LANE3+ DPB_LANE3-	D61 D62	DisplayPort B Lane3 output differential pair. Multiplexed with PEG_TX[3]+ and PEG_TX[3]- pair.	O PCIE		These signals are available when the "Display Channel 1 Output" setup node is set to DisplayPort B in the BIOS Setup Program.
DPB_LANE2+ DPB_LANE2-	D58 D59	DisplayPort B Lane2 output differential pair. Multiplexed with PEG_TX[2]+ and PEG_TX[2]- pair.	O PCIE		These signals are available when the "Display Channel 1 Output" setup node is set to DisplayPort B in the BIOS Setup Program.
DPB_LANE1+ DPB_LANE1-	D55 D56	DisplayPort B Lane1 output differential pair. Multiplexed with PEG_TX[1]+ and PEG_TX[1]- pair.	O PCIE		These signals are available when the "Display Channel 1 Output" setup node is set to DisplayPort B in the BIOS Setup Program.
DPB_LANE0+ DPB_LANE0-	D52 D53	DisplayPort B Lane0 output differential pair. Multiplexed with PEG_TX[0]+ and PEG_TX[0]- pair.	O PCIE		These signals are available when the "Display Channel 1 Output" setup node is set to DisplayPort B in the BIOS Setup Program.
DPB_HPD#	C61	DisplayPort B Hot-plug detect. Multiplexed with PEG_RX[3]+.	I PCIE	PU 2k7 to 0.9V	These signals are available when the "Display Channel 1 Output" setup node is set to DisplayPort B in the BIOS Setup Program.
DPB_AUX+ DPB_AUX-	C58 C59	DisplayPort B Aux input differential pair. Multiplexed with PEG_RX[2]+ and PEG_RX[2]- pair.	I/O PCIE		These signals are available when the "Display Channel 1 Output" setup node is set to DisplayPort B in the BIOS Setup Program.
DDPB_CTRLCLK	D73	HDMI port B Control Clock	I/OD 3.3V		Not connected
DDPB_CTRLDATA	C73	HDMI port B Control Data	I/OD 3.3V		Not connected
DPC_LANE3+ DPC_LANE3-	D74 D75	DisplayPort C Lane3 output differential pair. Multiplexed with PEG_TX[7]+ and PEG_TX[7]- pair.	O PCIE		These signals are available when the "Display Channel 0 Output" setup node is set to DisplayPort C in the BIOS Setup Program. Not connected if LVDS feature is available on conga-BAF.
DPC_LANE2+ DPC_LANE2-	D71 D72	DisplayPort C Lane2 output differential pair. Multiplexed with PEG_TX[6]+ and PEG_TX[6]- pair.	O PCIE		These signals are available when the "Display Channel 0 Output" setup node is set to DisplayPort C in the BIOS Setup Program. Not connected if LVDS feature is available on conga-BAF.
DPC_LANE1+ DPC_LANE1-	D68 D69	DisplayPort C Lane1 output differential pair. Multiplexed with PEG_TX[5]+ and PEG_TX[5]- pair.	O PCIE		These signals are available when the "Display Channel 0 Output" setup node is set to DisplayPort C in the BIOS Setup Program. Not supported if LVDS feature is supported on conga-BAF.
DPC_LANE0+ DPC_LANE0-	D65 D66	DisplayPort C Lane0 output differential pair. Multiplexed with PEG_TX[4]+ and PEG_TX[4]- pair.	O PCIE		These signals are available when the "Display Channel 0 Output" setup node is set to DisplayPort C in the BIOS Setup Program. Not connected if LVDS feature is available on conga-BAF.
DPC_HPD#	C74	DisplayPort C Hot-plug detect. Multiplexed with PEG_RX[7]+.	I PCIE	PU 2k7 to 0.9V	These signals are available when the "Display Channel 0 Output" setup node is set to DisplayPort C in the BIOS Setup Program. Not connected if LVDS feature is available on conga-BAF.
DPC_AUX+ DPC_AUX-	C71 C72	DisplayPort C Aux input differential pair. Multiplexed with PEG_RX[6]+ and PEG_RX[6]- pair.	I/O PCIE		These signals are available when the "Display Channel 0 Output" setup node is set to DisplayPort C in the BIOS Setup Program. Not connected if LVDS feature is available on conga-BAF.
DDPC_CTRLCLK	D63	HDMI port C Control Clock Uses COM Express Type 2 reserved (RSVD) pin D63	I/OD 3.3V		Not connected
DDPC_CTRLDATA	D64	HDMI port C Control Data Uses COM Express Type 2 reserved (RSVD) pin D64	I/OD 3.3V		Not connected

**Note**

When using the conga-HDMI/DisplayPort adapter card, jumper X20 must be used to set the Hot-Plug B input to low active.

**X20 Hot-Plug Detection active level for Port B**

Jumper X20	Configuration
1 - 2	High active hot-plug detect signal (default)
2 - 3	Low active hot-plug detect signal

**Jumper X20**

**Table 23 Module Type Definition Signal Description**

Signal	Pin #	Description	I/O	Comment																												
TYPE0# TYPE1# TYPE2#	C54 C57 D57	<p>The TYPE pins indicate to the Carrier Board the Pin-out Type that is implemented on the module. The pins are tied on the module to either ground (GND) or are no-connects (NC). For Pinout Type 1, these pins are don't care (X).</p> <table border="0"> <tr> <td>TYPE2#</td> <td>TYPE1#</td> <td>TYPE0#</td> <td></td> </tr> <tr> <td>X</td> <td>X</td> <td>X</td> <td>Pinout Type 1</td> </tr> <tr> <td>NC</td> <td>NC</td> <td>NC</td> <td>Pinout Type 2</td> </tr> <tr> <td>NC</td> <td>NC</td> <td>GND</td> <td>Pinout Type 3 (no IDE)</td> </tr> <tr> <td>NC</td> <td>GND</td> <td>NC</td> <td>Pinout Type 4 (no PCI)</td> </tr> <tr> <td>NC</td> <td>GND</td> <td>GND</td> <td>Pinout Type 5 (no IDE, no PCI)</td> </tr> <tr> <td>GND</td> <td>NC</td> <td>NC</td> <td>Pinout Type 6 (no IDE, no PCI)</td> </tr> </table> <p>The Carrier Board should implement combinatorial logic that monitors the module TYPE pins and keeps power off (e.g deactivates the ATX_ON signal for an ATX power supply) if an incompatible module pin-out type is detected. The Carrier Board logic may also implement a fault indicator such as an LED.</p>	TYPE2#	TYPE1#	TYPE0#		X	X	X	Pinout Type 1	NC	NC	NC	Pinout Type 2	NC	NC	GND	Pinout Type 3 (no IDE)	NC	GND	NC	Pinout Type 4 (no PCI)	NC	GND	GND	Pinout Type 5 (no IDE, no PCI)	GND	NC	NC	Pinout Type 6 (no IDE, no PCI)	PDS	<p>TYPE[0:2]# signals are available on all modules following the Type 2-6 Pinout standard.</p> <p>The conga-BAF is based on the COM Express Type 2 pinout therefore these pins are not connected.</p>
TYPE2#	TYPE1#	TYPE0#																														
X	X	X	Pinout Type 1																													
NC	NC	NC	Pinout Type 2																													
NC	NC	GND	Pinout Type 3 (no IDE)																													
NC	GND	NC	Pinout Type 4 (no PCI)																													
NC	GND	GND	Pinout Type 5 (no IDE, no PCI)																													
GND	NC	NC	Pinout Type 6 (no IDE, no PCI)																													
TYPE10#	A97	<p>Dual use pin. Indicates to the carrier board that a Type 10 module is installed. Indicates to the carrier that a Rev. 1.0/2.0 module is installed.</p> <p>TYPE10#</p> <table border="0"> <tr> <td>NC</td> <td>Pinout R2.0</td> </tr> <tr> <td>PD</td> <td>Pinout Type 10 pull down to ground with 4.7k resistor</td> </tr> <tr> <td>12V</td> <td>Pinout R1.0</td> </tr> </table> <p>This pin is reclaimed from VCC_12V pool. In R1.0 modules this pin will connect to other VCC_12V pins. In R2.0 this pin is defined as a no-connect for Types 1-6. A carrier can detect a R1.0 module by the presence of 12V on this pin. R2.0 module Types 1-6 will no-connect this pin. Type 10 modules shall pull this pin to ground through a 4.7k resistor.</p>	NC	Pinout R2.0	PD	Pinout Type 10 pull down to ground with 4.7k resistor	12V	Pinout R1.0	PDS	Not supported																						
NC	Pinout R2.0																															
PD	Pinout Type 10 pull down to ground with 4.7k resistor																															
12V	Pinout R1.0																															

**Table 24 Power and GND Signal Descriptions**

Signal	Pin #	Description	I/O	PU/PD	Comment
VCC_12V	C104-C109 D104-D109	Primary power input: +12V nominal. All available VCC_12V pins on the connector(s) shall be used.	P		
GND	C1, C11, C21, C31, C41, C51, C60, C70, C76, C80, C84, C87, C90, C93, C96, C100, C103, C110, D1, D11, D21, D31, D41, D51, D60, D67, D70, D76, D80, D84, D87, D90, D93, D96, D100, D103, D110	Ground - DC power and signal and AC signal return path. All available GND connector pins shall be used and tied to carrier board GND plane.	P		

**Table 25 Miscellaneous Signal Descriptions**

Signal	Pin #	Description	I/O	PU/PD	Comment
FAN_PWMOUT	C67	Fan speed control. Uses the Pulse Width Modulation (PWM) technique to control the fan's RPM.	O 3.3V	PU 10k	
FAN_TACHOIN	C77	Fan tachometer input.	I 3.3V	PU 10k	Requires a fan with a two pulse output.
TPM_PP	C83	Physical Presence pin of Trusted Platform Module (TPM). Active high. TPM chip has an internal pull-down. This signal is used to indicate Physical Presence to the TPM.	I 3.3V		Trusted Platform Module chip is optional.

## 8.4 C-D Connector Pinout

Table 26 Connector C-D Pinout

Pin	Row C	Pin	Row D	Pin	Row C	Pin	Row D
C1	GND (FIXED)	D1	GND (FIXED)	C56	PEG_RX1- (*)	D56	PEG_TX1- (**)
C2	IDE_D7	D2	IDE_D5	C57	TYPE1#	D57	TYPE2#
C3	IDE_D6	D3	IDE_D10	C58	PEG_RX2+ (**)	D58	PEG_TX2+ (**)
C4	IDE_D3	D4	IDE_D11	C59	PEG_RX2- (**)	D59	PEG_TX2- (**)
C5	IDE_D15	D5	IDE_D12	C60	GND (FIXED)	D60	GND (FIXED)
C6	IDE_D8	D6	IDE_D4	C61	PEG_RX3+ (**)	D61	PEG_TX3+ (**)
C7	IDE_D9	D7	IDE_D0	C62	PEG_RX3- (*)	D62	PEG_TX3- (**)
C8	IDE_D2	D8	IDE_REQ	C63	RSVD	D63	DDPC_CTRLCLK
C9	IDE_D13	D9	IDE_IOW#	C64	RSVD	D64	DDPC_CTRLDATA
C10	IDE_D1	D10	IDE_ACK#	C65	PEG_RX4+ (*)	D65	PEG_TX4+ (**)
C11	GND (FIXED)	D11	GND (FIXED)	C66	PEG_RX4- (*)	D66	PEG_TX4- (**)
C12	IDE_D14	D12	IDE_IRQ	C67	FAN_PWMOUT	D67	GND
C13	IDE_IORDY	D13	IDE_A0	C68	PEG_RX5+ (*)	D68	PEG_TX5+ (**)
C14	IDE_IOR#	D14	IDE_A1	C69	PEG_RX5- (*)	D69	PEG_TX5- (**)
C15	PCI_PME#	D15	IDE_A2	C70	GND (FIXED)	D70	GND (FIXED)
C16	PCI_GNT2#	D16	IDE_CS1#	C71	PEG_RX6+ (**)	D71	PEG_TX6+ (**)
C17	PCI_REQ2#	D17	IDE_CS3#	C72	PEG_RX6- (**)	D72	PEG_TX6- (**)
C18	PCI_GNT1#	D18	IDE_RESET#	C73	SDVO_DATA	D73	SVDO_CLK
C19	PCI_REQ1#	D19	PCI_GNT3#	C74	PEG_RX7+ (**)	D74	PEG_TX7+ (**)
C20	PCI_GNT0#	D20	PCI_REQ3#	C75	PEG_RX7- (*)	D75	PEG_TX7- (**)
C21	GND (FIXED)	D21	GND (FIXED)	C76	GND	D76	GND
C22	PCI_REQ0#	D22	PCI_AD1	C77	FAN_TACHOIN	D77	IDE_CBLID#
C23	PCI_RESET#	D23	PCI_AD3	C78	PEG_RX8+ (*)	D78	PEG_TX8+ (*)
C24	PCI_AD0	D24	PCI_AD5	C79	PEG_RX8- (*)	D79	PEG_TX8- (*)
C25	PCI_AD2	D25	PCI_AD7	C80	GND (FIXED)	D80	GND (FIXED)
C26	PCI_AD4	D26	PCI_C/BE0#	C81	PEG_RX9+ (*)	D81	PEG_TX9+ (*)
C27	PCI_AD6	D27	PCI_AD9	C82	PEG_RX9- (*)	D82	PEG_TX9- (*)
C28	PCI_AD8	D28	PCI_AD11	C83	PP_TPM	D83	RSVD
C29	PCI_AD10	D29	PCI_AD13	C84	GND	D84	GND
C30	PCI_AD12	D30	PCI_AD15	C85	PEG_RX10+ (*)	D85	PEG_TX10+ (*)
C31	GND (FIXED)	D31	GND (FIXED)	C86	PEG_RX10- (*)	D86	PEG_TX10- (*)
C32	PCI_AD14	D32	PCI_PAR	C87	GND	D87	GND
C33	PCI_C/BE1#	D33	PCI_SERR#	C88	PEG_RX11+ (*)	D88	PEG_TX11+ (*)
C34	PCI_PERR#	D34	PCI_STOP#	C89	PEG_RX11- (*)	D89	PEG_TX11- (*)
C35	PCI_LOCK#	D35	PCI_TRDY#	C90	GND (FIXED)	D90	GND (FIXED)
C36	PCI_DEVSEL#	D36	PCI_FRAME#	C91	PEG_RX12+ (*)	D91	PEG_TX12+ (*)
C37	PCI_IRDY#	D37	PCI_AD16	C92	PEG_RX12- (*)	D92	PEG_TX12- (*)

Pin	Row C	Pin	Row D	Pin	Row C	Pin	Row D
C38	PCI_C/BE2#	D38	PCI_AD18	C93	GND	D93	GND
C39	PCI_AD17	D39	PCI_AD20	C94	PEG_RX13+ (*)	D94	PEG_TX13+ (*)
C40	PCI_AD19	D40	PCI_AD22	C95	PEG_RX13- (*)	D95	PEG_TX13- (*)
C41	GND (FIXED)	D41	GND (FIXED)	C96	GND	D96	GND
C42	PCI_AD21	D42	PCI_AD24	C97	RSVD	D97	PEG_ENABLE#
C43	PCI_AD23	D43	PCI_AD26	C98	PEG_RX14+ (*)	D98	PEG_TX14+ (*)
C44	PCI_C/BE3#	D44	PCI_AD28	C99	PEG_RX14- (*)	D99	PEG_TX14- (*)
C45	PCI_AD25	D45	PCI_AD30	C100	GND (FIXED)	D100	GND (FIXED)
C46	PCI_AD27	D46	PCI_IRQC#	C101	PEG_RX15+ (*)	D101	PEG_TX15+ (*)
C47	PCI_AD29	D47	PCI_IRQD#	C102	PEG_RX15- (*)	D102	PEG_TX15- (*)
C48	PCI_AD31	D48	PCI_CLKRUN#	C103	GND	D103	GND
C49	PCI_IRQA#	D49	PCI_M66EN (*)	C104	VCC_12V	D104	VCC_12V
C50	PCI_IRQB#	D50	PCI_CLK	C105	VCC_12V	D105	VCC_12V
C51	GND (FIXED)	D51	GND (FIXED)	C106	VCC_12V	D106	VCC_12V
C52	PEG_RX0+ (*)	D52	PEG_TX0+ (**)	C107	VCC_12V	D107	VCC_12V
C53	PEG_RX0- (*)	D53	PEG_TX0- (**)	C108	VCC_12V	D108	VCC_12V
C54	TYPE0#	D54	PEG_LANE_RV# (*)	C109	VCC_12V	D109	VCC_12V
C55	PEG_RX1+ (*)	D55	PEG_TX1+ (**)	C110	GND (FIXED)	D110	GND (FIXED)



*The signals marked with an asterisk symbol (\*) are not supported on the conga-BAF. The signals marked with a double asterisk symbol (\*\*) are used for alternate interfaces on the conga-BAF.*

## 8.5 Boot Strap Signals

**Table 27 Boot Strap Signal Descriptions**

Signal	Pin #	Description of Boot Strap Signal	I/O	PU/PD	Comment
AC/HDA_SDOUT	A33	<b>High Definition Audio Serial Data Out:</b> This signal is the serial TDM data output to the codec(s). This serial output is double-pumped for a bit rate of 48 Mb/s for High Definition Audio.	O 3.3VSB	PD 10k	AC/HDA_SDOUT is a boot strap signal (see caution statement below)
LPC_CLK	B10	LPC clock output - 33MHz nominal	O 3.3V	PD 10k	LPC_CLK is a boot strap signal (see note below).



### Caution

*The signals listed in the table above are used as chipset configuration straps during system reset. In this condition (during reset), they are inputs that are pulled to the correct state by either COM Express™ internally implemented resistors or chipset internally implemented resistors that are located on the module. No external DC loads or external pull-up or pull-down resistors should change the configuration of the signals listed in the above table. External resistors may override the internal strap states and cause the COM Express™ module to malfunction and/or cause irreparable damage to the module.*

## 9 System Resources

### 9.1 I/O Address Assignment

The I/O address assignment of the conga-BAF module is functionally identical with a standard PC/AT. The most important addresses and the ones that differ from the standard PC/AT configuration are listed in the table below.



*The BIOS assigns PCI and PCI Express I/O resources from FFF0h downwards. Non PnP/PCI/PCI Express compliant devices must not consume I/O resources in that area.*

#### 9.1.1 LPC Bus

On the conga-BAF the PCI Bus acts as the subtractive decoding agent. All I/O cycles that are not positively decoded are forwarded to the PCI Bus not the LPC Bus. Only specified I/O ranges are forwarded to the LPC Bus. In the congatec Embedded BIOS the following I/O address ranges are sent to the LPC Bus:

2Eh – 2Fh  
4Eh – 4Fh  
60h, 64h  
2F8h – 2FFh  
378h – 37Fh  
3F8h – 3FFh  
778h – 77Fh  
A00h – BFFh

Parts of these ranges are not available if a Super I/O is used on the carrier board. If a Super I/O is not implemented on the carrier board then these ranges are available for customer use. If you require additional LPC Bus resources other than those mentioned above, or more information about this subject, contact congatec technical support for assistance.



## 9.2 Interrupt Request (IRQ) Lines

**Table 28** IRQ Lines in PIC mode

IRQ#	Available	Typical Interrupt Source	Connected to Pin
0	No	Counter 0	Not applicable
1	No	Keyboard	Not applicable
2	No	Cascade Interrupt from Slave PIC	Not applicable
3	Yes		IRQ3 via SERIRQ or PCI BUS INTx
4	Yes		IRQ4 via SERIRQ or PCI BUS INTx
5	Yes		IRQ5 via SERIRQ
6	Yes		IRQ6 via SERIRQ or PCI BUS INTx
7	Yes		IRQ7 via SERIRQ or PCI BUS INTx
8	No	Real-time Clock	Not applicable
9	No	SCI	Not applicable
10	Yes		IRQ10 via SERIRQ or PCI BUS INTx
11	Yes		IRQ11 via SERIRQ or PCI BUS INTx
12	Yes		IRQ12 via SERIRQ or PCI BUS INTx
13	No	Math processor	Not applicable
14	Note	IDE Controller 0 (IDE0) / Generic	IRQ14 via SERIRQ or PCI BUS INTx
15	Note	IDE Controller 1 (IDE1) / Generic	IRQ15 via SERIRQ or PCI BUS INTx

**Note**

*If the SATA and PATA interface mode configuration in BIOS setup is NOT set to legacy IDE mode, IRQ14 and 15 are free for PCI/LPC bus.*

**Table 29 IRQ Lines in APIC mode**

IRQ#	Available	Typical Interrupt Source	Connected to Pin / Function
0	No	Counter 0	Not applicable
1	No	Keyboard	Not applicable
2	No	Cascade Interrupt from Slave PIC	Not applicable
3	Yes		IRQ3 via SERIRQ
4	Yes		IRQ4 via SERIRQ
5	Yes		IRQ5 via SERIRQ
6	Yes		IRQ6 via SERIRQ
7	Yes		IRQ7 via SERIRQ
8	No	Real-time Clock	Not applicable
9	No	SCI	Not applicable
10	Yes		IRQ10 via SERIRQ
11	Yes		IRQ11 via SERIRQ
12	Yes		IRQ12 via SERIRQ
13	No	Math processor	Not applicable
14	Yes (Note 1)	IDE Controller 0 (IDE0) / Generic	IRQ14 via SERIRQ
15	Yes (Note 1)	IDE Controller 1 (IDE1) / Generic	IRQ15 via SERIRQ
16	No		PIRQA, PCI Express Root Port 0/4/5/6, onboard Gigabit LAN Controller, PCI Express Port 0 (see Note 2).
17	No		PIRQB, PCI Express Root Port 1, PCI Express Port 1 (see Note 2), PCI Express Port 4 (see Note 2), IDE Host Controller 1 (PATA Port), EHCI Host Controller 0, EHCI Host Controller 1.
18	No		PIRQC, PCI Express Root Port 2, PCI Express Port 2 (see Note 2), PCI Express Port 5 (see Note 2), OHCI Host Controller 0, OHCI Host Controller 1, Integrated Graphics Controller.
19	No		PIRQD, PCI Express Root Port 3, PCI Express Port 3 (see Note 2), IDE Host Controller 1 (SATA Ports), HDMI / Display Port HDA Controller (for HDMI/Display Port integrated audio only).
20	Yes		PIRQE, PCI BUS INTA, Main High Definition Audio Controller
21	Yes		PIRQF, PCI BUS INTB
22	Yes		PIRQG, PCI BUS INTC
23	Yes		PIRQH, PCI BUS INTD

In APIC mode, the PCI bus interrupt lines are connected with IRQ 20, 21, 22 and 23.

**Note**

1. If the SATA and PATA interface mode configuration in BIOS setup is NOT set to legacy IDE mode, IRQ14 and 15 are free for PCI/LPC bus.
2. Interrupt used if a single function PCI Express device is connected to the respective PCI Express port.

## 9.3 PCI Configuration Space Map

**Table 30 PCI Configuration Space Map**

Bus Number (hex)	Device Number (hex)	Function Number (hex)	PCI Interrupt Routing	Description
00h	00h	00h	N.A.	Host Bridge
00h	01h	00h	Internal	Integrated Graphics Controller (VGA)
00h	01h	01h	Internal	HDMI/Display Port HDA Controller (for HDMI/DisplayPort integrated audio only)
00h (see Note 1)	04h	00h	Internal	PCI Express Root Port 0
00h (see Note 1)	05h	00h	Internal	PCI Express Root Port 1
00h (see Note 1)	06h	00h	Internal	PCI Express Root Port 2
00h (see Note 1)	07h	00h	Internal	PCI Express Root Port 3
00h	11h	00h	Internal	IDE Controller 0 (SATA Ports)
00h	12h	00h	Internal	OHCI Host Controller 0
00h	12h	02h	Internal	EHCI Host Controller 0
00h	13h	00h	Internal	OHCI Host Controller 1
00h	13h	02h	Internal	EHCI Host Controller 1
00h	14h	00h	N.A.	SMBus Host Controller
00h	14h	01h	Internal	IDE Controller 1 (PATA Port)
00h	14h	02h	Internal	High Definition Audio Controller
00h	14h	03h	N.A.	PCI to LPC Bridge
00h	14h	04h	N.A.	PCI to PCI Bridge
00h	15h	00h	Internal	PCI Express Root Port 4
00h (see Note 1)	15h	01h	Internal	PCI Express Root Port 5
00h (see Note 1)	15h	02h	Internal	PCI Express Root Port 6
00h	18h	00h	N.A.	Chipset Configuration Registers
00h	18h	01h	N.A.	Chipset Configuration Registers
00h	18h	02h	N.A.	Chipset Configuration Registers
00h	18h	03h	N.A.	Chipset Configuration Registers
00h	18h	04h	N.A.	Chipset Configuration Registers
00h	18h	05h	N.A.	Chipset Configuration Registers
00h	18h	06h	N.A.	Chipset Configuration Registers
00h	18h	07h	N.A.	Chipset Configuration Registers
01h (see Note 2)	00h	00h	Internal	PCI Express Port 0
02h (see Note 2)	00h	00h	Internal	PCI Express Port 1
03h (see Note 2)	00h	00h	Internal	PCI Express Port 2
04h (see Note 2)	00h	00h	Internal	PCI Express Port 3
05h (see Note 2)	04h	00h	INTA-INTD	PCI Bus Slot 1
05h (see Note 2)	05h	00h	INTA-INTD	PCI Bus Slot 2
05h (see Note 2)	06h	00h	INTA-INTD	PCI Bus Slot 3

05h (see Note 2)	07h	00h	INTA-INTD	PCI Bus Slot 4
06h (see Note 2)	00h	00h	Internal	Onboard Gigabit LAN Controller
07h (see Note 2)	00h	00h	Internal	PCI Express Port 4
08h (see Note 2)	00h	00h	Internal	PCI Express Port 5

**Note**

- 1. The PCI Express Ports are only visible if the PCI Express Port is set to “Enabled” in the BIOS setup program and a device is attached to the corresponding PCI Express port on the carrier board.*
- 2. The above table represents a case when a single function PCI/PCIe device is connected to all possible slots on the carrier board. The given bus numbers will change based on the actual configuration of the hardware .*

## 9.4 PCI Interrupt Routing Map

Table 31 PCI Interrupt Routing Map

PIRQ	PCI BUS INT Line <sup>1</sup>	APIC Mode IRQ	VGA	HDA (HDMI / DP)	OHCI 0	OHCI 1	EHCI 0	EHCI 1	IDE 0	IDE 1	HDA (Main)
A		16									
B		17					x	x		x	
C		18	x		x	x					
D		19		x					x		
E	INTA	20									x
F	INTB	21									
G	INTC	22									
H	INTD	23									

PCI Interrupt Routing Map (continued)

PIRQ	PCI-EX Root Port 0	PCI-EX Root Port 1	PCI-EX Root Port 2	PCI-EX Root Port 3	PCI-EX Root Port 4	PCI-EX Root Port 5	PCI-EX Root Port 6	PCI-EX Port 0	PCI-EX Port 1	PCI-EX Port 2	PCI-EX Port 3	PCI-EX Port 4	PCI-EX Port 5	LAN
A	x				x	x	x	x <sup>2</sup>	x <sup>5</sup>	x <sup>4</sup>	x <sup>3</sup>	x <sup>5</sup>	x <sup>4</sup>	x
B		x						x <sup>3</sup>	x <sup>2</sup>	x <sup>5</sup>	x <sup>4</sup>	x <sup>2</sup>	x <sup>5</sup>	
C			x					x <sup>4</sup>	x <sup>3</sup>	x <sup>2</sup>	x <sup>5</sup>	x <sup>3</sup>	x <sup>2</sup>	
D				x				x <sup>5</sup>	x <sup>4</sup>	x <sup>3</sup>	x <sup>2</sup>	x <sup>4</sup>	x <sup>3</sup>	
E														
F														
G														
H														

**Note**

- <sup>1</sup> These interrupts are available for external devices/slots via the C-D connector rows.
- <sup>2</sup> Interrupt used by single function PCI Express devices (INTA).
- <sup>3</sup> Interrupt used by multifunction PCI Express devices (INTB).
- <sup>4</sup> Interrupt used by multifunction PCI Express devices (INTC).
- <sup>5</sup> Interrupt used by multifunction PCI Express devices (INTD).

## 9.5 PCI Bus Masters

The conga-BAF supports 4 external PCI Bus Masters. There are no limitations in connecting bus master PCI devices.



*If there are two devices connected to the same PCI REQ/GNT pair and they are transferring data at the same time then the latency time of these shared PCI devices can not be guaranteed.*

## 9.6 I<sup>2</sup>C Bus

There are no onboard resources connected to the I<sup>2</sup>C bus. Address 16h is reserved for congatec Battery Management solutions.

## 9.7 SM Bus

System Management (SM) bus signals are connected to the AMD A55E FCH and the SM bus is not intended to be used by off-board non-system management devices. For more information about this subject contact congatec technical support.

## 10 BIOS Setup Description

The following section describes the BIOS setup program. The BIOS setup program can be used to view and change the BIOS settings for the module. Only experienced users should change the default BIOS settings.

### 10.1 Entering the BIOS Setup Program.

The BIOS setup program can be accessed by pressing the <DEL> or <F2> key during POST.

#### 10.1.1 Boot Selection Popup

The BIOS offers the possibility to access a Boot Selection Popup menu by pressing the <F11> key during POST. If this option is used, a selection will be displayed immediately after POST allowing the operator to select either the boot device that should be used or an option to enter the BIOS setup program.

### 10.2 Setup Menu and Navigation

The congatec BIOS setup screen is composed of the menu bar and two main frames. The menu bar is shown below:

Main	Advanced	Boot	Security	Save & Exit
------	----------	------	----------	-------------

The left frame displays all the options that can be configured in the selected menu. Grayed-out options cannot be configured. Only the blue options can be configured. When an option is selected, it is highlighted in white.



#### Note

*Entries in the option column that are displayed in bold print indicate BIOS default values.*

The right frame displays the key legend. Above the key legend is an area reserved for text messages. These text messages explain the options and the possible impacts when changing the selected option in the left frame.

The setup program uses a key-based navigation system. Most of the keys can be used at any time while in setup. The table below explains the supported keys:

Key	Description
← → Left/Right	Select a setup menu (e.g. Main, Boot, Exit).
↑ ↓ Up/Down	Select a setup item or sub menu.
+ - Plus/Minus	Change the field value of a particular setup item.
Tab	Select setup fields (e.g. in date and time).
F1	Display General Help screen.
F2	Load previous settings.
F9	Load optimal default settings.
F10	Save changes and exit setup.
ESC	Discard changes and exit setup.
ENTER	Display options of a particular setup item or enter submenu.

## 10.3 Main Setup Screen

When you first enter the BIOS setup, you will enter the Main setup screen. You can always return to the Main setup screen by selecting the Main tab. The Main screen reports BIOS, processor, memory and board information and is for configuring the system date and time.

Feature	Options	Description
<b>BIOS Information</b>		
Main BIOS Version	no option	Displays the main BIOS version.
OEM BIOS Version	no option	Displays the additional OEM BIOS version.
Build Date	no option	Displays the date the BIOS was built.
<b>Board Information</b>		
Product Revision	no option	Displays the hardware revision of the board.
Serial Number	no option	Displays the serial number of the board.
BC Firmware Rev.	no option	Displays the revision of the congatec board controller.
MAC Address	no option	Displays the MAC address of the onboard Ethernet controller.
Boot Counter	no option	Displays the number of boot-ups. (max. 16777215).
Running Time	no option	Displays the time the board is running [in hours max. 65535].
<b>Memory Information</b>		
Total Memory	no option	Displays amount of installed memory.
Memory Clock	no option	Displays current memory clock.
<b>CPU Information</b>		
CPU Information	no option	Displays CPU type and feature information
System Date	Day of the week, month/day/year	Specifies the current system date <i>Note: The date is in month/day/year format.</i>
System Time	Hour:Minute:Second	Specifies the current system time. <i>Note: The time is in 24 hour format.</i>



## 10.4 Advanced Setup

Select the Advanced tab from the setup menu to enter the Advanced BIOS Setup screen. The menu is used for setting advanced features:

Main	Advanced	Boot	Security	Save & Exit
	Graphics Configuration			
	Watchdog Configuration			
	PCI & PCI Express Configuration			
	ACPI Configuration			
	RTC Wake Settings			
	Trusted Computing Configuration			
	CPU Configuration			
	Chipset Configuration			
	Hardware Health Monitoring			
	SATA/PATA Configuration			
	USB Configuration			
	Super I/O Configuration			
	Serial Port Console Redirection			

## 10.4.1 Graphics Configuration Submenu

Feature	Options	Description
Primary Graphics Device	<b>IGD</b> PCI/PCIe	Select primary graphics adapter to be used during boot up. IGD: Internal Graphics Device. PCI/PCIe: Try to use external standard PCI Express or PCI Graphics Device. If not present, IGD is used.
Integrated Graphics Device	<b>Auto Configuration</b> Disabled Manual Configuration	Deactivate IGD or select frame buffer configuration mode. In auto mode, the frame buffer size will be defined based on the amount of physical memory present.
IGD Frame buffer Size	32M 64M 128M <b>256M</b> 512M	Only visible if IGD is set to manual configuration. Set fixed graphics frame buffer size for IGD. The graphics driver may allocate additional memory.
Display Channel 0 Output	DisplayPort C HDMI C <b>LVDS</b> Disabled	Define output mode and connection of the integrated digital display channel 0. <i>Note: The different output options require different, additional hardware support. Thus not all options can actually work on the same module variant.</i>
Display Channel 1 Output	<b>DisplayPort B</b> HDMI B Disabled	Define output mode and connection of the integrated digital display channel 1. <i>Note: The different output options require different, additional hardware support. Thus not all options can actually work on the same module variant.</i>
IGD Boot Display Device	<b>Auto</b> CRT Only Display Channel 0 Display Channel 1 CRT + Display Channel 0 CRT + Display Channel 1 Display Channel 0 + 1	Select the IGD display device(s) used for boot up.
Always Try Auto Panel Detect	<b>No</b> Yes	If set to 'Yes' the BIOS will first look for an EDID data set in an external EEPROM to configure the LVDS flat panel output. The data set selected under 'Local Flat Panel Type' will be used as fallback data set only if no external EDID data set can be found.

Feature	Options	Description
Local Flat Panel Type	<b>Auto</b> VGA 640x480 1x18 (002h) VGA 640x480 1x18 (013h) WVGA 800x480 1x24 (01Bh) SVGA 800x600 1x18 (01Ah) XGA 1024x768 1x18 (006h) XGA 1024x768 2x18 (007h) XGA 1024x768 1x24 (008h) XGA 1024x768 2x24 (012h) WXGA 1280x768 1x24 (01Ch) SXGA 1280x1024 2x24 (00Ah) SXGA 1280x1024 2x24 (018h) UXGA 1600x1200 2x24 (00Ch) HD 1920x1080 2x24 (01Dh) WUXGA 1920x1200 2x18 (015h) WUXGA 1920x1200 2x24 (00Dh) Customized EDID™ 1 Customized EDID™ 2 Customized EDID™ 3	Select a predefined LFP type or choose Auto to let the BIOS automatically detect and configure the attached LVDS panel. Auto detection is performed by reading an EDID data set via the video I <sup>2</sup> C bus. The number in brackets specifies the congatec internal number of the respective panel data set. <i>Note: Customized EDID™ utilizes an OEM defined EDID™ data set stored in the BIOS flash device.</i>
Backlight Inverter Type	<b>None</b> PWM I2C PWM (no ACPI)	Select the type of backlight inverter used. PWM = Use IGD PWM signal. I2C = Use I2C backlight inverter device connected to the video I <sup>2</sup> C bus. PWM (no ACPI) = Use IGD PWM signal; no ACPI interface provided.
PWM Inverter Frequency (Hz)	<b>200</b> -40000	Only visible if Backlight Inverter Type is set to PWM. Set the PWM inverter frequency in Hertz.
Backlight Setting	0%, 10%, 25%, 40%, 50%, 60%, 75%, 90%, <b>100%</b>	Actual backlight value in percent of the maximum setting.
Inhibit Backlight	<b>No</b> Permanent Until End Of POST	Decide whether the backlight on signal should be activated when the panel is activated or whether it should remain inhibited until the end of BIOS POST or permanently.
Invert Backlight Setting	<b>No</b> Yes	Allow to invert backlight setting values if required for the actual backlight hardware controller.
LVDS SSC	<b>Disabled</b> Enabled	Enable or disable LVDS spread spectrum clock modulation.
SSC Modulation Frequency	<b>30kHz</b> 35kHz 40kHz	Select the LVDS SSC modulation frequency.
SSC Modulation Percentage	<b>0.25%</b> , 0.50%, 0.75%, 1.00%, 1.25%, 1.50%, 1.75%	Select the LVDS SSC modulation percentage.

## 10.4.2 Watchdog Configuration Submenu

Feature	Options	Description
POST Watchdog	<b>Disabled</b> 30sec 1min 2min 5min 10min 30min	Select the timeout value for the POST watchdog.  The watchdog is only active during the power-on-self-test of the system and provides a facility to prevent errors during boot up by performing a reset..
Stop Watchdog for User Interaction	No <b>Yes</b>	Select whether the POST watchdog should be stopped during the popup boot selection menu or while waiting for setup password insertion.
Runtime Watchdog	<b>Disabled</b> One time Trigger Single Event Repeated Event	Selects the operating mode of the runtime watchdog. This watchdog will be initialized just before the operating system starts booting. If set to ' <i>One time Trigger</i> ' the watchdog will be disabled after the first trigger. If set to ' <i>Single Event</i> ', every stage will be executed only once, then the watchdog will be disabled. If set to ' <i>Repeated Event</i> ' the last stage will be executed repeatedly until a reset occurs.
Delay	<b>Disabled</b> 10sec 30sec 1min 2min 5min 10min 30min	Select the delay time before the runtime watchdog becomes active. This ensures that an operating system has enough time to load.
Event 1	NMI ACPI Event <b>Reset</b> Power Button	Selects the type of event that will be generated when timeout 1 is reached. For more information about ACPI Event, see note below.
Event 2	<b>Disabled</b> NMI ACPI Event Reset Power Button	Selects the type of event that will be generated when timeout 2 is reached.
Event 3	<b>Disabled</b> NMI ACPI Event Reset Power Button	Selects the type of event that will be generated when timeout 3 is reached.

Feature	Options	Description
Timeout 1	1sec	Selects the timeout value for the first stage watchdog event.
	2sec	
	5sec	
	10sec	
	<b>30sec</b>	
	1min	
	2min	
	5min	
	10min	
	30min	
Timeout 2	see above	Selects the timeout value for the second stage watchdog event.
Timeout 3	see above	Selects the timeout value for the third stage watchdog event.
Watchdog ACPI Event	<b>Shutdown</b>	Select the operating system event that is initiated by the watchdog ACPI event. These options perform a critical but orderly operating system shutdown or restart.
	Restart	

**Note**

*In ACPI mode it is not possible for a “Watchdog ACPI Event” handler to directly restart or shutdown the OS. For this reason the congatec BIOS will do one of the following:*

*For Shutdown: An over temperature notification is executed. This causes the OS to shut down in an orderly fashion.*

*For Restart: An ACPI fatal error is reported to the OS.*

### 10.4.3 PCI & PCI Express Configuration Submenu

Feature	Options	Description
PCI ROM Priority	Legacy ROM <b>EFI Compatible ROM</b>	Specify which PCI option ROM to launch in case multiple option ROMs (legacy and EFI compatible) are present.
Launch PXE Option ROM	<b>Disabled</b> Enabled	Enable or disable start of PXE option ROMs for external legacy network devices.
Launch Storage Option ROM	Disabled <b>Enabled</b>	Enable or disable start of option ROMs for legacy mass storage devices.
PCI Settings		
PCI Latency Timer	<b>32</b> , 64, 96, 128, 160, 192, 224, 248 PCI Bus Clocks	Select value to be programmed into PCI latency timer register.
VGA Palette Snoop	<b>Disabled</b> Enabled	Enable or disable VGA palette registers snooping.

Feature	Options	Description
PERR# Generation	<b>Disabled</b> Enabled	Enable or disable PCI device SERR# generation.
SERR# Generation	<b>Disabled</b> Enabled	Enable or disable PCI device SERR# generation.
► PIRQ Routing	submenu	Opens the PIRQ routing submenu
PCI Express Device & Link Settings		
Relaxed Ordering	<b>Disabled</b> Enabled	Enable or disable PCI Express device relaxed ordering.
Extended Tag	<b>Disabled</b> Enabled	If enabled a device may use an 8-bit tag filed as a requester.
No Snoop	Disabled <b>Enabled</b>	Enable or disable PCI Express device 'No Snoop' option.
Maximum Payload	<b>Auto</b> 128 Bytes 256 Bytes 512 Bytes 1024 Bytes 2048 Bytes 4096 Bytes	Set maximum payload of PCI Express devices or allow system BIOS to select the value.
Maximum Read Request	<b>Auto</b> 128 Bytes 256 Bytes 512 Bytes 1024 Bytes 2048 Bytes 4096 Bytes	Set maximum read request size of PCI Express devices or allow system BIOS to select the value.
Extended Synch	<b>Disabled</b> Enabled	If enabled, the generation of extended PCI Express synchronization patterns is allowed.

### 10.4.3.1 PIRQ Routing Submenu

Feature	Options	Description
PIRQA	<b>Auto</b> IRQ3 IRQ4 IRQ6 IRQ7 IRQ10 IRQ11 IRQ14 IRQ15	Set interrupt for selected PIRQ. Refer to the module's resource list of devices connected to the respective PIRQ. <i>Note: These settings will only be effective while operating in PIC (non IOAPIC) interrupt mode.</i>
PIRQB	See above	See above
PIRQC	See above	See above

Feature	Options	Description
PIRQD	See above	See above
PIRQE (PCI INTA)	See above	See above
PIRQF (PCI INTA)	See above	See above
PIRQG (PCI INTA)	See above	See above
PIRQH (PCI INTA)	See above	See above

#### 10.4.4 ACPI Configuration Submenu

Feature	Options	Description
Hibernation Support	Disabled <b>Enabled</b>	Enable or disable system ability to hibernate (operating system S4 sleep state). This option may not be effective with some operating systems.
ACPI Sleep State	Suspend Disabled <b>S3 (Suspend to RAM)</b>	Select the state used for ACPI system sleep/suspend.
S3 Video Repost	<b>Disabled</b> Enabled	Enable or disable video BIOS re-post on S3 resume. Required by some operating systems.
USB Device Wakeup From S3 or S4	Disabled <b>Enabled</b>	Enable or disable USB device wakeup support from S3 or S4. Additional operating systems may be required as well.
Active Trip Point	Disabled, 20, 30, 40, 50, <b>60</b> , 70, 80, 90, 95°C	Specifies the temperature threshold at which the ACPI aware OS turns the fan on/off.
Passive Trip Point	Disabled, 60, 70, 80, 90, <b>95°C</b>	Specifies the temperature threshold at which the ACPI aware OS starts/stops CPU clock throttling.

#### 10.4.5 RTC Wake Settings Submenu

Feature	Options	Description
Wake System At Fixed Time	<b>Disabled</b> Enabled	Enable system to wake from S5 using RTC alarm.
Wake up hour		Specify wake up hour.
Wake up minute		Specify wake up minute.
Wake up second		Specify wake up second.

## 10.4.6 Trusted Computing Configuration Submenu

Feature	Options	Description
TPM Support	<b>Disabled</b> Enabled	Enable or disable TPM support. System reset is required after change.
TPM State	<b>Disabled</b> Enabled	Enable or disable TPM chip. <i>Note: System may restart several times during POST to acquire target state.</i>
Pending TPM Operation	<b>None,</b> Enable Take Ownership, Disable Take Ownership, TPM Clear	Perform selected TPM chip operation. <i>Note: System may restart several times during POST to perform selected operation.</i>

## 10.4.7 CPU Configuration Submenu

Feature	Options	Description
Limit CPUID Maximum	<b>Disabled</b> Enabled	When <b>Enabled</b> , the processor will limit the maximum CPUID input value to 03h when queried, even if the processor supports a higher CPUID input value. When <b>Disabled</b> , the processor will return the actual maximum CPUID input value of the processor when queried. Limiting the CPUID input value may be required for older operating systems that cannot handle the extra CPUID information returned when using the full CPUID input value.
AMD PowerNow! Support	Disabled <b>Enabled</b>	Enable or disable support for AMD PowerNow! Technology. Allows operating systems to control CPU performance states.
Maximum OS P-State	<b>P-State 0</b> P-State 1 P-State 2 P-State 3 P-State 4	Select the maximum CPU performance state the operating system should support. Higher numbers mean lower performance. P-state 0 is the highest performance state.
Maximum Power Up P-State	<b>P-State 0</b> P-State 1 P-State 2 P-State 3 P-State 4	Select the maximum CPU performance state to be set at power up. Higher numbers mean lower performance. P-state 0 is the highest performance state.
NX Mode	Disabled <b>Enabled</b>	Enable or disable the 'no-execute' page protection function.
Virtualization Technology	Disabled <b>Enabled</b>	When enabled, a Virtual Machine Manager (VMM) can utilize the integrated hardware virtualization support.
C6 Support	<b>Disabled</b> Enabled	Enable or disable CPU C6 low power state support.
Core Performance Boost	<b>Auto</b> Disabled	Controls usage of boosted CPU P-states, i.e. P-states above the standard CPU P-state limit. Availability of boosted P-states depends on CPU type and revision, actual usage on total CPU/GPU power consumption.



## 10.4.8 Chipset Configuration Submenu

Feature	Options	Description
Memory Bank Interleaving	<b>Disabled</b> Enabled	Enable or disable memory bank interleaving.
Memory Bus Clock	<b>Auto</b> 400MHz (DDR3-800) 533MHz (DDR3-1066)	Select or limit memory frequency.
HDA Controller	Auto Disabled <b>Enabled</b>	Control activation of the High Definition Audio controller.
HDMI/DP Audio Support	Disabled <b>Enabled</b>	Enable or disable HDMI/DisplayPort integrated audio support.
Onboard LAN	Disabled <b>Enabled</b>	Enable or disable the onboard ethernet controller.
Launch Onboard LAN PXE ROM	<b>Disabled</b> Enabled	Enable or disable PXE option ROM execution of the onboard ethernet controller.
POST Code Output	<b>PCI Bus</b> LPC Bus	Control where the port 80h cycles are sent.
PCI Express Port 0-3 Configuration	1 x4 Port 2 x2 Ports 1 x2 Port + 2 x1 Ports <b>4 x1 Ports</b>	Select configuration of PCI Express ports 0-3.
Port 4/5 PCIe Gen2 Support	Disabled <b>Enabled</b>	PCI Express ports 4 and 5 are handled by the southbridge of the module. This node controls whether PCI Express generation 2 speed should be supported for these ports as well.
PCI Express Port 0	Disabled <b>Enabled</b>	Enable or disable PCI Express port. <i>Note: Unless the hotplug support for this port is enabled as well, an unpopulated port will still be disabled if no PCI Express device is connected.</i>
Link Speed	<b>Auto</b> PCIe Gen1 PCIe Gen2	Control link speed for this PCI Express port.
Hotplug Support	<b>Disabled</b> Enabled	Enable or disable hotplug support for the respective port.
PCI Express Port 1	Disabled <b>Enabled</b>	Enable or disable PCI Express port. <i>Note: Unless the hotplug support for this port is enabled as well, an unpopulated port will still be disabled if no PCI Express device is connected.</i>
Link Speed	<b>Auto</b> PCIe Gen1 PCIe Gen2	Control link speed for this PCI Express port.
Hotplug Support	<b>Disabled</b> Enabled	Enable or disable hotplug support for the respective port.
PCI Express Port 2	Disabled <b>Enabled</b>	Enable or disable PCI Express port. <i>Note: Unless the hotplug support for this port is enabled as well, an unpopulated port will still be disabled if no PCI Express device is connected.</i>

Feature	Options	Description
Link Speed	<b>Auto</b> PCIe Gen1 PCIe Gen2	Control link speed for this PCI Express port.
Hotplug Support	<b>Disabled</b> Enabled	Enable or disable hotplug support for the respective port.
PCI Express Port 3	Disabled <b>Enabled</b>	Enable or disable PCI Express port. <i>Note: Unless the hotplug support for this port is enabled as well, an unpopulated port will still be disabled if no PCI Express device is connected.</i>
Link Speed	<b>Auto</b> PCIe Gen1 PCIe Gen2	Control link speed for this PCI Express port.
Hotplug Support	<b>Disabled</b> Enabled	Enable or disable hotplug support for the respective port.
PCI Express Port 4	Disabled <b>Enabled</b>	Enable or disable PCI Express port. <i>Note: Unless the hotplug support for this port is enabled as well, an unpopulated port will still be disabled if no PCI Express device is connected.</i>
Hotplug Support	<b>Disabled</b> Enabled	Enable or disable hotplug support for the respective port.
PCI Express Port 5	Disabled <b>Enabled</b>	Enable or disable PCI Express port. <i>Note: Unless the hotplug support for this port is enabled as well, an unpopulated port will still be disabled if no PCI Express device is connected.</i>
Hotplug Support	<b>Disabled</b> Enabled	Enable or disable hotplug support for the respective port.

## 10.4.9 Hardware Health Monitoring Submenu

Feature	Options	Description
CPU Temperature	no option	Current CPU temperature.
Southbridge Temperature	no option	Current southbridge temperature.
Board Temperature	no option	Current board temperature.
Top. DIMM Env. Temperature	no option	Current top side DIMM environment temperature.
12V Standard	no option	Current 12V input reading.
5V Standby	no option	Current 5V standby input reading.
Memory Voltage	no option	Current memory voltage reading.
CPU Fan Speed	no option	Current CPU fan speed reading.

## 10.4.10 SATA/PATA Configuration Submenu

Feature	Options	Description
SATA Interface Mode	<b>Native IDE</b> RAID AHCI Legacy IDE	Select onboard SATA controller interface mode.
PATA Interface Mode	<b>Legacy IDE</b> Native IDE	Select interface mode of the controller handling the PATA port.
SATA Port 0	<b>Enabled</b> Disabled	Enable or disable selected port.
Port Speed	<b>Auto</b> Gen1 Gen2	Select SATA speed generation for the selected port.
SATA Port 1	<b>Enabled</b> Disabled	Enable or disable selected port.
Port Speed	<b>Auto</b> Gen1 Gen2	Select SATA speed generation for the selected port.
SATA Port 2	<b>Enabled</b> Disabled	Enable or disable selected port.
Port Speed	<b>Auto</b> Gen1 Gen2	Select SATA speed generation for the selected port.
SATA Port 3	<b>Enabled</b> Disabled	Enable or disable selected port.
Port Speed	<b>Auto</b> Gen1 Gen2	Select SATA speed generation for the selected port.
PATA Port	Enabled <b>Disabled</b>	Enable or disable selected port.
PATA Port Detection Timeout	1, 2, <b>3</b> , 5, 10, 20, 30 seconds	Define the maximum time to wait for drive detection on PATA port.

## 10.4.11 USB Configuration Submenu

Feature	Options	Description
USB Port 0	Disabled <b>Enabled</b>	Enable or disable selected port.
USB Port 1	Disabled <b>Enabled</b>	Enable or disable selected port.
USB Port 2	Disabled <b>Enabled</b>	Enable or disable selected port.
USB Port 3	Disabled <b>Enabled</b>	Enable or disable selected port.
USB Port 4	Disabled <b>Enabled</b>	Enable or disable selected port.
USB Port 5	Disabled <b>Enabled</b>	Enable or disable selected port.
USB Port 6	Disabled <b>Enabled</b>	Enable or disable selected port.
USB Port 7	Disabled <b>Enabled</b>	Enable or disable selected port.
USB Overcurrent Reporting	Disabled <b>Enabled</b>	Select whether activation of the USB overcurrent signals results in USB overcurrent register reporting and software event handling as well.
Legacy USB Support	<b>Enabled</b> Disabled Auto	Enables legacy USB support. Auto option disables legacy support if no USB devices are connected. Disable option will keep USB devices available only for EFI applications and setup.
EHCI Hand-off	<b>Disabled</b> Enabled	This is a workaround for operating systems without EHCI hand-off support. The EHCI ownership change should be claimed by the EHCI OS driver.
► Per-Port Legacy USB Support Control	submenu	Opens the Per-Port Legacy USB Support Control submenu
USB Transfer Timeout	1 sec 5sec 10 sec <b>20 sec</b>	Timeout value for legacy USB control, bulk and interrupt transfers.
Device Reset Timeout	10 sec <b>20 sec</b> 30 sec 40 sec	USB legacy mass storage device Start Unit command timeout.
Device Power-Up Delay Selection	<b>Auto</b> Manual	Define maximum time a USB device might need before it properly reports itself to the host controller. Auto selects a default value, which is 100ms for a root port or derived from the hub descriptor for a hub port.
Device Power-Up Delay Value	<b>5</b> 1-40	Actual power-up delay value in seconds.

Feature	Options	Description
USB Mass Storage Device Name  <i>(Auto detected USB mass storage devices are listed here dynamically)</i>	<b>Auto</b> Floppy Forced FDD Hard Disk CD-ROM	<p>Every USB mass storage device that is enumerated by the BIOS will have an emulation type setup option. This option specifies the type of emulation the BIOS has to provide for the device.</p> <p><i>Note: The device's formatted type and the emulation type provided by the BIOS must match for the device to boot properly.</i></p> <p>Select AUTO to let the BIOS auto detect the current formatted media.            If Floppy is selected then the device will be emulated as a floppy drive.            Forced FDD allows a hard disk image to be connected as a floppy image. Works only for drives formatted with FAT12, FAT16 or FAT32.            Hard Disk allows the device to be emulated as hard disk.            CD-ROM assumes the CD-ROM is formatted as bootable media, specified by the 'El Torito' Format Specification.</p>

### 10.4.11.1 Per-Port Legacy USB Support Control Submenu

Feature	Options	Description
USB0 Port Legacy Support	Disabled <b>Enabled</b>	Enable or disable legacy USB support for this port. Enabled is only effective if the port is not disabled by another setting in the USB configuration menu.
USB1 Port Legacy Support	See above	See above
USB2 Port Legacy Support	See above	See above
USB3 Port Legacy Support	See above	See above
USB4 Port Legacy Support	See above	See above
USB5 Port Legacy Support	See above	See above
USB6 Port Legacy Support	See above	See above
USB7 Port Legacy Support	See above	See above

### 10.4.12 Super I/O Configuration Submenu

Feature	Options	Description
Serial Port 0	Disabled <b>Enabled</b>	Enable or disable serial port 0.
Device Settings	IO=3F8h; IRQ=4;	Fixed configuration of serial port 0 if enabled.
Serial Port 1	Disabled <b>Enabled</b>	Enable or disable serial port 1.
Device Settings	IO=2F8h; IRQ=3;	Fixed configuration of serial port 1 if enabled.
Parallel Port	<b>Disabled</b> Enabled	Enable or disable parallel port.
Device Settings	IO=378h; IRQ=7;	Fixed configuration of the parallel port if enabled.
Device Mode	<b>Standard Parallel Mode</b> EPP Mode ECP Mode EPP Mode & ECP Mode	Set the parallel port mode.

**Note**

*This setup menu is only available if an external Winbond W83627 Super I/O has been implemented on the carrier board.*

## 10.4.13 Serial Port Console Redirection

Feature	Options	Description
COM0 Console Redirection	<b>Disabled</b> Enabled	Enable or disable serial port 0 console redirection.
► Console Redirection Settings	submenu	Opens the console redirection configuration submenu.
COM1 Console Redirection	<b>Disabled</b> Enabled	Enable or disable serial port 1 console redirection.
► Console Redirection Settings	submenu	Opens the console redirection configuration submenu.

### 10.4.13.1 Console Redirection Settings Submenu

Feature	Options	Description
Terminal Type	VT100 VT100+ VT-UTF8 <b>ANSI</b>	Select terminal type.
Baudrate	9600, 19200, 38400, 57600, <b>115200</b>	Select baudrate.
Data Bits	7, <b>8</b>	Set number of data bits.
Parity	<b>None</b> Even Odd Mark Space	Select parity.
Stop Bits	<b>1</b> 2	Set number of stop bits.
Flow Control	<b>None</b> Hardware RTS/CTS	Select flow control.
Recorder Mode	<b>Disabled</b> Enabled	With recorder mode enabled, only text output will be sent over the terminal. This is helpful to capture and record terminal data.
Resolution 100x31	<b>Disabled</b> Enabled	Enables or disables extended terminal resolution in UEFI environment.
Legacy OS Redirection Resolution	<b>80x24</b> 80x25	Number of rows and columns supported for legacy OS redirection.

## 10.5 Boot Setup

Select the Boot tab from the setup menu to enter the Boot setup screen.

### 10.5.1 Boot Settings Configuration

Feature	Options	Description
Quiet Boot	<b>Disabled</b> Enabled	<i>Disabled</i> displays normal POST diagnostic messages. <i>Enabled</i> displays OEM logo instead of POST messages. <i>Note: The default OEM logo is a dark screen.</i>
Setup Prompt Timeout	<b>1</b> 0 - 65535	Number of seconds to wait for setup activation key. 0 means no wait for fastest boot, 65535 means infinite wait.
POST/Setup VGA Support	<b>Disabled</b> Enabled	Select VGA mode for setup and POST screen. Enables setup and POST screen output support for VGA and WVGA display resolutions.
Bootup NumLock State	<b>On</b> Off	Select the keyboard numlock state.
Enter Setup if No Boot Device	<b>No</b> Yes	Select whether the setup menu should be started if no boot device is connected.
Enable Popup Boot Menu	No <b>Yes</b>	Select whether the popup boot menu can be started.
Boot Priority Selection	Device Based <b>Type Based</b>	Select between device and type based boot priority lists. The "Device Based" boot priority list allows you to select from a list of currently detected devices only. The "Type Based" boot priority list allows you to select device types, even if a respective device is not yet present. Moreover, the "Device Based" boot priority list might change dynamically in cases when devices are physically removed or added to the system. The "Type Based" boot menu is static and can only be changed by the user.
1st, 2nd, 3rd, ... Boot Device	Disabled SATA 0 Drive SATA 1 Drive SATA 2 Drive SATA 3 Drive PATA Drive USB Floppy USB Hard disk USB CDROM Onboard LAN External LAN Other BEV Device OEM BEV Device	This view is only available when in the default "Type Based" mode.  When in "Device Based" mode you will only see the devices that are currently connected to the system.
(Up to 12 boot devices can be prioritized if device based priority list control is selected. If "Type Based" priority list control is enabled only 8 boot devices can be prioritized.)		
Power Loss Control	<b>Remain Off</b> Turn On Last State	Specifies the mode of operation if an AC power loss occurs. Remain Off keeps the power off until the power button is pressed. Turn On restores power to the computer. Last State restores the previous power state before power loss occurred. <i>Note: Only works with an ATX type power supply.</i>

Feature	Options	Description
AT Shutdown Mode	<b>System Reboot</b> Hot S5	Determines the behavior of an AT-powered system after a shutdown.
System Off Mode	<b>G3/Mech Off</b> S5/Soft Off	Define system state after shutdown when a battery system is present.
GateA20 Active	<b>Upon Request</b> Always	Gate A20 control. Upon Request = Gate A20 can be disabled using BIOS services. Always = Do not allow disabling Gate A20.
Option ROM Messages	<b>Force BIOS</b> Keep Current	Set display mode for option ROMs.
Interrupt 19 Capture	<b>Disabled</b> Enabled	Defines whether option ROMs may trap the INT19h legacy boot vector.

**Note**

1. The term 'AC power loss' stands for the state when the module loses the standby voltage on the 5V\_SB pins. On congatec modules, the standby voltage is continuously monitored after the system is turned off. If within 30 seconds the standby voltage is no longer detected, then this is considered an AC power loss condition. If the standby voltage remains stable for 30 seconds, then it is assumed that the system was switched off properly.
2. Inexpensive ATX power supplies often have problems with short AC power sags. When using these ATX power supplies it is possible that the system turns off but does not switch back on, even when the PS\_ON# signal is asserted correctly by the module. In this case, the internal circuitry of the ATX power supply has become confused. Usually another AC power off/on cycle is necessary to recover from this situation.
3. Unlike other module designs available in the embedded market, a CMOS battery is not required by congatec modules to support the 'Power Loss Control' feature.



## 10.6 Security Setup

Select the Security tab from the setup menu to enter the Security setup screen.

### 10.6.1 Security Settings Submenu

Feature	Options	Description
Setup Administrator Password	enter password	Specifies the setup administrator password.
<b>► HDD Security Configuration</b>		
<i>List of all detected hard disks supporting the security feature set.</i>	Select device to open device security configuration submenu	

### 10.6.2 Hard Disk Security Submenu

This feature enables the users to set, reset or disable passwords for each hard drive in Setup without rebooting. If the user enables password support, a power cycle must occur for the hard drive to lock using the new password. Both user and master password can be set independently however the drive will only lock if a user password is installed.

## 10.7 Save & Exit Setup

Select the Save & Exit tab from the setup menu to enter the Save & Exit setup screen.

You can display a Save & Exit screen option by highlighting it using the <Arrow> keys.

Feature	Description
Save Changes and Exit	Exit setup menu after saving the changes. The system is only reset if settings have been changed.
Discard Changes and Exit	Exit setup menu without saving any changes.
Save Changes and Reset	Save changes and reset the system.
Discard Changes and Reset	Reset the system without saving any changes.
<b>► Save Options</b>	
Save Changes	Save changes made so far to any of the setup options. Stay in setup menu.
Discard Changes	Discard changes made so far to any of the setup options. Stay in setup menu.
Restore Defaults	Restore default values for all the setup options.
<b>► Boot Override</b>	
<i>List of all boot devices currently detected.</i>	Select device to leave setup menu and boot from the selected device. Only visible and active if Boot Priority Selection setup node is set to "Device Based".

# 11 Additional BIOS Features

The conga-BAF uses a congatec/AMI AptioEFI firmware that is stored in an onboard Flash Rom chip and can be updated using the congatec System Utility, which is available in a DOS based command line, Win32 command line, Win32 GUI, and Linux version.

The BIOS displays a message during POST and on the main setup screen identifying the BIOS project name and a revision code. The initial production BIOS is identified as BBRAR1xx, where BBRA is the congatec internal BIOS project name for conga-BAF, R is the identifier for a BIOS ROM file, 1 is the so called feature number and xx is the major and minor revision number.

The size of the conga-BAF BIOS binary is approximately 4MB.

## 11.1 Supported Flash Devices

The conga-BAF supports the following flash devices:

- Atmel AT25DF321-SU
- Silicon Storage Technology SST25VF032B-66-4I-S2AF
- Macronix MX25L3206EM2I-12G

The flash devices listed above can be used on the carrier board for external BIOS support. For more information about external BIOS support, refer to the Application Note AN7\_External\_BIOS\_Update.pdf on the congatec website at <http://www.congatec.com>.

## 11.2 Updating the BIOS

BIOS updates are often used by OEMs to correct platform issues discovered after the board has been shipped or when new features are added to the BIOS.

For more information about “Updating the BIOS” refer to the user’s guide for the congatec System Utility, which is called CGUTLm1x.pdf and can be found on the congatec AG website at [www.congatec.com](http://www.congatec.com).

## 11.3 BIOS Security Features

The BIOS provides a setup administrator password that limits access to the BIOS setup menu.

## 11.4 Hard Disk Security Features

Hard Disk Security uses the Security Mode feature commands defined in the ATA specification. This functionality allows users to protect data using drive-level passwords. The passwords are kept within the drive, so data is protected even if the drive is moved to another computer system.

The BIOS provides the ability to 'lock' and 'unlock' drives using the security password. A 'locked' drive will be detected by the system, but no data can be accessed. Accessing data on a 'locked' drive requires the proper password to 'unlock' the disk.

The BIOS enables users to enable/disable hard disk security for each hard drive in setup. A master password is available if the user can not remember the user password. Both passwords can be set independently however the drive will only lock if a user password is installed. The max length of the passwords is 32 bytes.

During POST each hard drive is checked for security mode feature support. In case the drive supports the feature and it is locked, the BIOS prompts the user for the user password. If the user does not enter the correct user password within five attempts, the user is notified that the drive is locked and POST continues as normal. If the user enters the correct password, the drive is unlocked until the next reboot.

In order to ensure that the ATA security features are not compromised by viruses or malicious programs when the drive is typically unlocked, the BIOS disables the ATA security features at the end of POST to prevent their misuse. Without this protection it would be possible for viruses or malicious programs to set a password on a drive thereby blocking the user from accessing the data.

## 12 Industry Specifications

---

The list below provides links to industry specifications that apply to congatec AG modules.

Specification	Link
Low Pin Count Interface Specification, Revision 1.0 (LPC)	<a href="http://developer.intel.com/design/chipsets/industry/lpc.htm">http://developer.intel.com/design/chipsets/industry/lpc.htm</a>
Universal Serial Bus (USB) Specification, Revision 2.0	<a href="http://www.usb.org/home">http://www.usb.org/home</a>
PCI Specification, Revision 2.3	<a href="http://www.pcisig.com/specifications">http://www.pcisig.com/specifications</a>
Serial ATA Specification, Revision 1.0a	<a href="http://www.serialata.org">http://www.serialata.org</a>
PICMG® COM Express Module™ Base Specification	<a href="http://www.picmg.org/">http://www.picmg.org/</a>
PCI Express Base Specification, Revision 2.0	<a href="http://www.pcisig.com/specifications">http://www.pcisig.com/specifications</a>