

conga-STX7

Detailed description of the congatec COM Express™ Type 7 carrier board



User's Guide

Revision 1.6

Revision History

Revision	Date (yyyy-mm-dd)	Author	Changes
0.1	2020-02-12	AEM	<ul style="list-style-type: none">• Preliminary release
1.0	2020-07-24	AEM	<ul style="list-style-type: none">• Added section 6 "BMC Configuration and Management"• Official release
1.1	2020-12-08	AEM	<ul style="list-style-type: none">• Corrected the diameter of connector X43 in section 4.1.1 "DC Power Jack"• Added note that X48 is optional on hardware rev. A.3 in section 4.3 "Board to Board Connector (PCIe x16)"• Corrected the dimensions in section 9 "Mechanical Dimensions"
1.2	2021-04-20	AEM	<ul style="list-style-type: none">• Corrected the supported modules in section 1.2 "conga-STX7" and table 1 "Feature Summary"
1.3	2021-08-02	AEM	<ul style="list-style-type: none">• Added Software License Information• Changed congatec AG to congatec GmbH
1.4	2022-03-16	AEM	<ul style="list-style-type: none">• Deleted industrial temperature from section 3.4 "Environmental Specifications"
1.5	2022-06-17	AEM	<ul style="list-style-type: none">• Corrected the operating temperature range in section 3.1 "Feature List"
1.6	2024-01-22	AEM	<ul style="list-style-type: none">• Updated the title page• Updated the RoHS statement• Added a note about optimal storage conditions to section 3.4 "Environmental Specifications"

Preface

This user's guide provides information about the components, features and connectors available on the congatec COM Express™ Type 7 carrier board.

Software Licenses

Notice Regarding Open Source Software

The congatec products contain Open Source software that has been released by programmers under specific licensing requirements such as the "General Public License" (GPL) Version 2 or 3, the "Lesser General Public License" (LGPL), the "ApacheLicense" or similar licenses.

You can find the specific details at <https://www.congatec.com/en/licenses/>. Search for the revision of the BIOS/UEFI or Board Controller Software (as shown in the POST screen or BIOS setup) to get the complete product related license information. To the extent that any accompanying material such as instruction manuals, handbooks etc. contain copyright notices, conditions of use or licensing requirements that contradict any applicable Open Source license, these conditions are inapplicable.

The use and distribution of any Open Source software contained in the product is exclusively governed by the respective Open Source license. The Open Source software is provided by its programmers without ANY WARRANTY, whether implied or expressed, of any fitness for a particular purpose, and the programmers DECLINE ALL LIABILITY for damages, direct or indirect, that result from the use of this software.

OEM/ CGUTL BIOS

BIOS/UEFI modified by customer via the congatec System Utility (CGUTL) is subject to the same license as the BIOS/UEFI it is based on. You can find the specific details at <https://www.congatec.com/en/licenses/>.

Disclaimer

The information contained within this user's guide, including but not limited to any product specification, is subject to change without notice.

congatec GmbH provides no warranty with regard to this user's guide or any other information contained herein and hereby expressly disclaims any implied warranties of merchantability or fitness for any particular purpose with regard to any of the foregoing. congatec GmbH assumes no liability for any damages incurred directly or indirectly from any technical or typographical errors or omissions contained herein or for discrepancies between the product and the user's guide. In no event shall congatec GmbH be liable for any incidental, consequential, special, or exemplary damages, whether based on tort, contract or otherwise, arising out of or in connection with this user's guide or any other information contained herein or the use thereof.

Intended Audience

This user's guide is intended for technically qualified personnel. It is not intended for general audiences.

RoHS Directive

All congatec GmbH designs comply with EU RoHS Directive 2011/65/EU and Delegated Directive 2015/863.

Electrostatic Sensitive Device



All congatec GmbH products are electrostatic sensitive devices. They are enclosed in static shielding bags, and shipped enclosed in secondary packaging (protective packaging). The secondary packaging does not provide electrostatic protection.

Do not remove the device from the static shielding bag or handle it, except at an electrostatic-free workstation. Also, do not ship or store electronic devices near strong electrostatic, electromagnetic, magnetic, or radioactive fields unless the device is contained within its original packaging. Be aware that failure to comply with these guidelines will void the congatec GmbH Limited Warranty.

Copyright Notice

Copyright © 2020, congatec GmbH. All rights reserved. All text, pictures and graphics are protected by copyrights. No copying is permitted without written permission from congatec GmbH.

congatec GmbH has made every attempt to ensure that the information in this document is accurate yet the information contained within is supplied "as-is".

Trademarks

Product names, logos, brands, and other trademarks featured or referred to within this user's guide, or the congatec website, are the property of their respective trademark holders. These trademark holders are not affiliated with congatec GmbH, our products, or our website.

Symbols

The following symbols are used in this user's guide:



Warning

Warnings indicate conditions that, if not observed, can cause personal injury.



Caution

Cautions warn the user about how to prevent damage to hardware or loss of data.



Note

Notes call attention to important information that should be observed.



Connector Type

Describes the connector on the congatec COM Express™ carrier board and possible mating connector.



Link to connector layout diagram

This link icon is located in the top left corner of each page. It provides a direct link to the connector layout diagram on page 8 of this document.

Certification

congatec GmbH is certified to DIN EN ISO 9001 standard.



Warranty

congatec GmbH makes no representation, warranty or guaranty, express or implied regarding the products except its standard form of limited warranty ("Limited Warranty") per the terms and conditions of the congatec entity, which the product is delivered from. These terms and conditions can be downloaded from www.congatec.com. congatec GmbH may in its sole discretion modify its Limited Warranty at any time and from time to time.

The products may include software. Use of the software is subject to the terms and conditions set out in the respective owner's license agreements, which are available at www.congatec.com and/or upon request.

Beginning on the date of shipment to its direct customer and continuing for the published warranty period, congatec GmbH represents that the products are new and warrants that each product failing to function properly under normal use, due to a defect in materials or workmanship or due to non conformance to the agreed upon specifications, will be repaired or exchanged, at congatec's option and expense.

Customer will obtain a Return Material Authorization ("RMA") number from congatec GmbH prior to returning the non conforming product freight prepaid. congatec GmbH will pay for transporting the repaired or exchanged product to the customer.

Repaired, replaced or exchanged product will be warranted for the repair warranty period in effect as of the date the repaired, exchanged or replaced product is shipped by congatec, or the remainder of the original warranty, whichever is longer. This Limited Warranty extends to congatec's direct customer only and is not assignable or transferable.

Except as set forth in writing in the Limited Warranty, congatec makes no performance representations, warranties, or guarantees, either express or implied, oral or written, with respect to the products, including without limitation any implied warranty (a) of merchantability, (b) of fitness for a particular purpose, or (c) arising from course of performance, course of dealing, or usage of trade.

congatec GmbH shall in no event be liable to the end user for collateral or consequential damages of any kind. congatec shall not otherwise be liable for loss, damage or expense directly or indirectly arising from the use of the product or from any other cause. The sole and exclusive remedy against congatec, whether a claim sound in contract, warranty, tort or any other legal theory, shall be repair or replacement of the product only.

Technical Support

congatec GmbH technicians and engineers are committed to providing the best possible technical support for our customers so that our products can be easily used and implemented. We request that you first visit our website at www.congatec.com for the latest documentation, utilities and drivers, which have been made available to assist you. If you still require assistance after visiting our website then contact our technical support department by email at support@congatec.com

Terminology

Term	Description
BMC	Board Management Controller
GbE	Gigabit Ethernet
HDA	High Definition Audio
IPMI	Intelligent Platform Management interface
I ² C Bus	Inter-Integrated Circuit Bus
KCS	Keyboard Controller Style
KVM	Keyboard, Video and Mouse
MAC	Media Access Control
N.A	Not available
N.C	Not connected
NCSI	Network Controller Sideband Interface
PCIe	Peripheral Component Interface Express (PCI Express)
SATA	Serial AT Attachment
SFP+	Enhanced Small Form-factor Pluggable
SNMP	Simple Network Management Protocol
SMBus	System Management Bus
SoL	Serial Over LAN
T.B.D	To be determined
USB	Universal Serial Bus

Contents

1	Introduction	11	4.13	Feature Connector	37
1.1	COM Express™ Concept.....	11	5	BMC Overview	39
1.2	conga-STX7	11	5.1	Firmware	39
2	Connector Layout	12	5.2	Features	39
3	Specifications	14	6	BMC Configuration and Management	41
3.1	Feature List	14	6.1	Before You Begin	41
3.2	Mechanical Dimensions	15	6.2	Enable BMC Support in BIOS Setup Menu	41
3.3	Supply Voltage Power.....	15	6.3	BMC IP Address	42
3.4	Environmental Specifications	15	6.3.1	Configure IP Using BIOS Setup Menu	42
4	Connector Description.....	16	6.3.2	Configure IP Using Ipmitool in Linux	45
4.1	Power Supply Connectors.....	20	7	BMC Access and Management.....	46
4.1.1	DC Power Jack.....	20	7.1	Local BMC Management (KCS).....	46
4.1.2	Mini-Fit 4-Pin Connector.....	20	7.1.1	Local Access Using BIOS Setup Menu.....	46
4.1.3	CMOS Battery Connector.....	21	7.1.2	Local Access Using Ipmitool (Linux).....	47
4.1.4	Status LEDs	21	7.1.2.1	Test the Interface	47
4.2	Extension Sockets	22	7.1.2.2	Sensor Readings	48
4.2.1	M.2 Key B Socket.....	22	7.1.2.3	System Event Log	49
4.2.2	M.2 Key M Socket.....	24	7.1.2.4	LAN Configuration Parameters	49
4.2.2.1	HDD LED Pin Header.....	25	7.1.2.5	Chassis Power Control	51
4.3	Board to Board Connector (PCIe x16)	26	7.2	Remote BMC Management	52
4.4	PCI Express® Routing	29	7.2.1	Remote Access Using BMC Web Interface	52
4.5	VGA Connector.....	30	7.2.1.1	Supported Browsers	52
4.6	SFP+ (10 Gbe) Connector.....	31	7.2.1.2	Logging In	52
4.7	RJ45 (1 GbE) Connector	31	7.2.1.3	KVM Remote Control Operation	56
4.7.1	PHY/MAC Management Headers.....	32	7.2.2	Remote Access Using Ipmitool (Linux).....	62
4.8	USB Connector	33	7.2.3	Using Serial Over LAN (SoL)	63
4.9	UART Header	33	7.2.3.1	SoL Configuration	63
4.9.1	RS232 UART Header.....	33	7.2.3.2	Using Serial Over LAN (SoL)	67
4.9.2	General Purpose Serial Ports	34	8	Additional Features.....	73
4.10	Fan Header	35	8.1	Buttons.....	73
4.11	SPI Flash Socket.....	35	8.1.1	Power.....	73
4.12	Front Panel Header.....	36	8.1.2	Reset	73

8.2	PC Speaker	73
8.3	Ground Test Points.....	74
8.4	SMBus	74
8.5	I ² C Bus.....	74
8.6	LPC Bus.....	74
8.7	PWR_OK	75
8.8	Module Type Detection	75
9	Mechanical Dimensions	76



List of Tables

Table 1	Feature Summary.....	14
Table 2	Module Type 7 Connector Pinout—Rows A and B.....	16
Table 3	Module Type 7 Connector Pinout—Rows C and D.....	18
Table 4	X43 Pinout Description.....	20
Table 5	X44 Pinout Description.....	20
Table 6	X31/X49 Description.....	21
Table 7	Status LED Description.....	21
Table 8	X42 Pinout Description.....	22
Table 9	X40/X41 Pinout Description.....	24
Table 10	Header X39 Pinout Description.....	25
Table 11	X48 Pinout Description.....	26
Table 12	X13 Pinout Description.....	30
Table 13	GbE Pinout Description.....	31
Table 14	X3 Pinout Description.....	32
Table 15	X14 Pinout Description.....	32
Table 16	X25/X26 Pinout Description.....	33
Table 17	Possible Serial Port Configuration.....	34
Table 18	SW3 Pinout Description.....	34
Table 19	X36/X38 Pinout Description.....	35
Table 20	M19 Pinout Description.....	36
Table 21	X50/X51/X52 Pinout Description.....	36
Table 22	X32 Pinout Description.....	37
Table 23	MegaRAC Menu Bar Description.....	55
Table 24	Ipmitool Remote Commands.....	62
Table 25	Module Type Detection Pinout Description.....	75



1 Introduction

1.1 COM Express™ Concept

COM Express™ is an open industry standard defined specifically for COMs (computer on modules). Its creation makes it possible to smoothly transition from legacy interfaces to the newest technologies available today.

A Computer On Module integrates all the core components and standard I/O interfaces of a common PC onto an application specific carrier board. The key advantage of the COM in the embedded computer industries is that all the highly-integrated, high-speed components such as CPU, chipsets and memory are combined on a small module form factor for easy adaptation into different applications across multiple market segments.

COM Express™ modules have standardized form factors and specified pinouts on the two system connectors that remain the same regardless of the vendor. The COM Express™ module reflects the functional requirements for a wide range of embedded applications. These functions include, but are not limited to PCI Express, graphics, high definition audio, serial ATA, gigabit Ethernet and USB ports. Two ruggedized, shielded connectors provide the carrier board interface and carry all the I/O signals to and from the COM Express™ module.

Carrier board designers can use as little or as many of the I/O interfaces as deemed necessary. The carrier board can therefore provide all the interface connectors required to attach the system to the application specific peripherals. This versatility allows the designer to create a dense and optimized package. The result is a more reliable product with simplified system integration.

Most importantly, COM Express™ modules are scalable. Once an application has been created, the product range can be diversified by using different performance class or form factor size modules. Simply unplug one module and replace it with another; no redesign is necessary.

1.2 conga-STX7

The conga-STX7 carrier board design is based on Type 7 pinout definition and it complies with COM Express Specification 3.0. The carrier board comes in Intel Mini-STX form factor and supports the congatec conga-B7E3 and conga-B7AC modules.

The conga-STX7 provides most of the functional requirements for server application. These functions include, but are not limited to a rich complement of contemporary high bandwidth interfaces such as PCI Express, Serial ATA, USB 3.0/2.0, and 10 Gb SFP+.

By combining the scalability of congatec COM Express type 7 modules, the conga-STX7 carrier board provides manufacturers and developers with a platform to jump-start the development of systems and applications based on COM Express Type 7 specification. This helps to reduce product design cycle and encourages rapid innovation in system design, to meet the ever-changing needs of the market.



2 Connector Layout

The connector layout picture shows each connector and its designator.

Select the Adobe 'Zoom-In-Tool' and zoom in on a given component to see its designator. Hover over the component and the 'Zoom-In-Tool' will change indicating there is a link.

Click on the link to navigate to the area in the document where the component is described.

Use the mouse icon in the top left hand corner of the destination page to return to the connector layout picture.

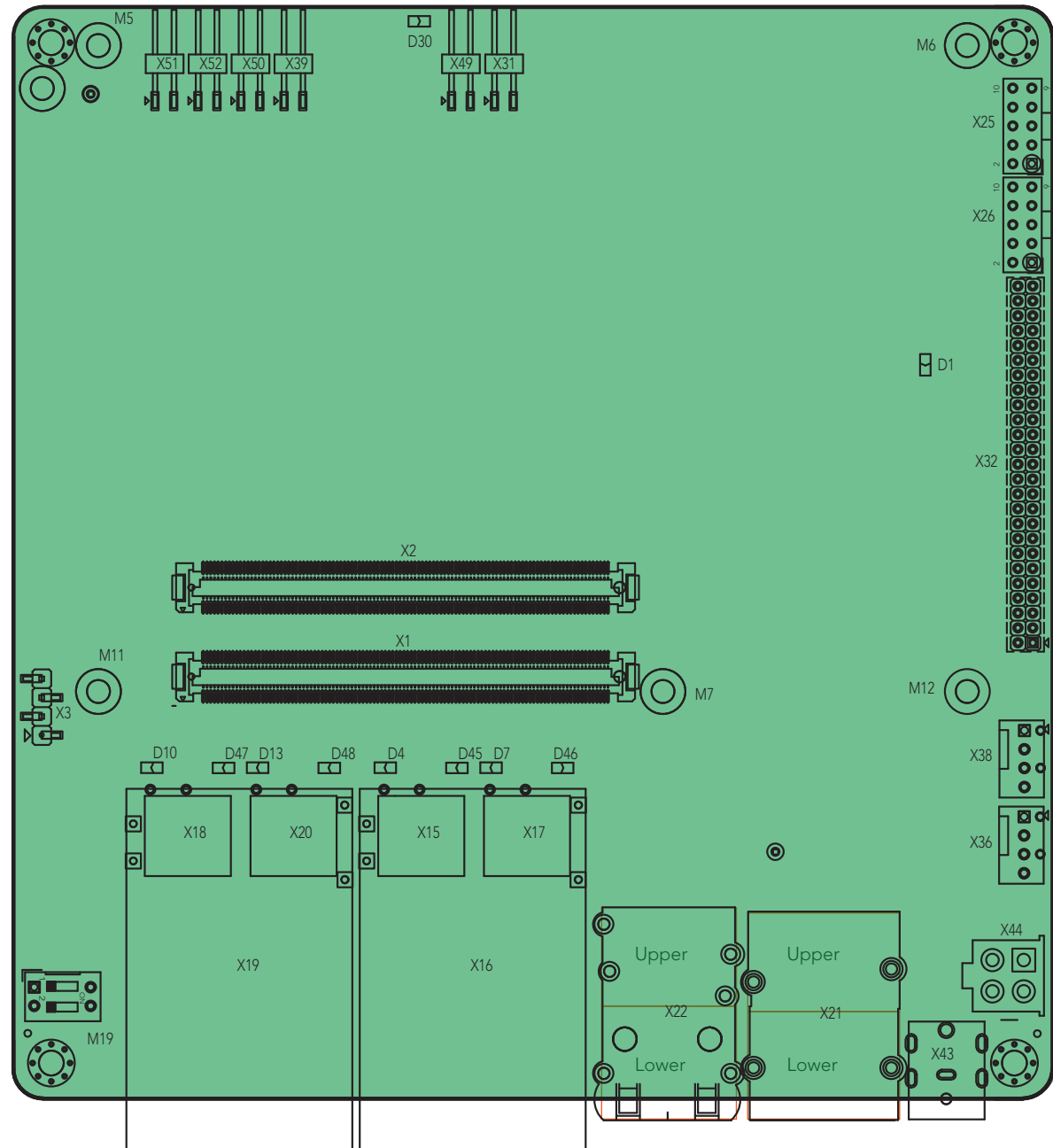

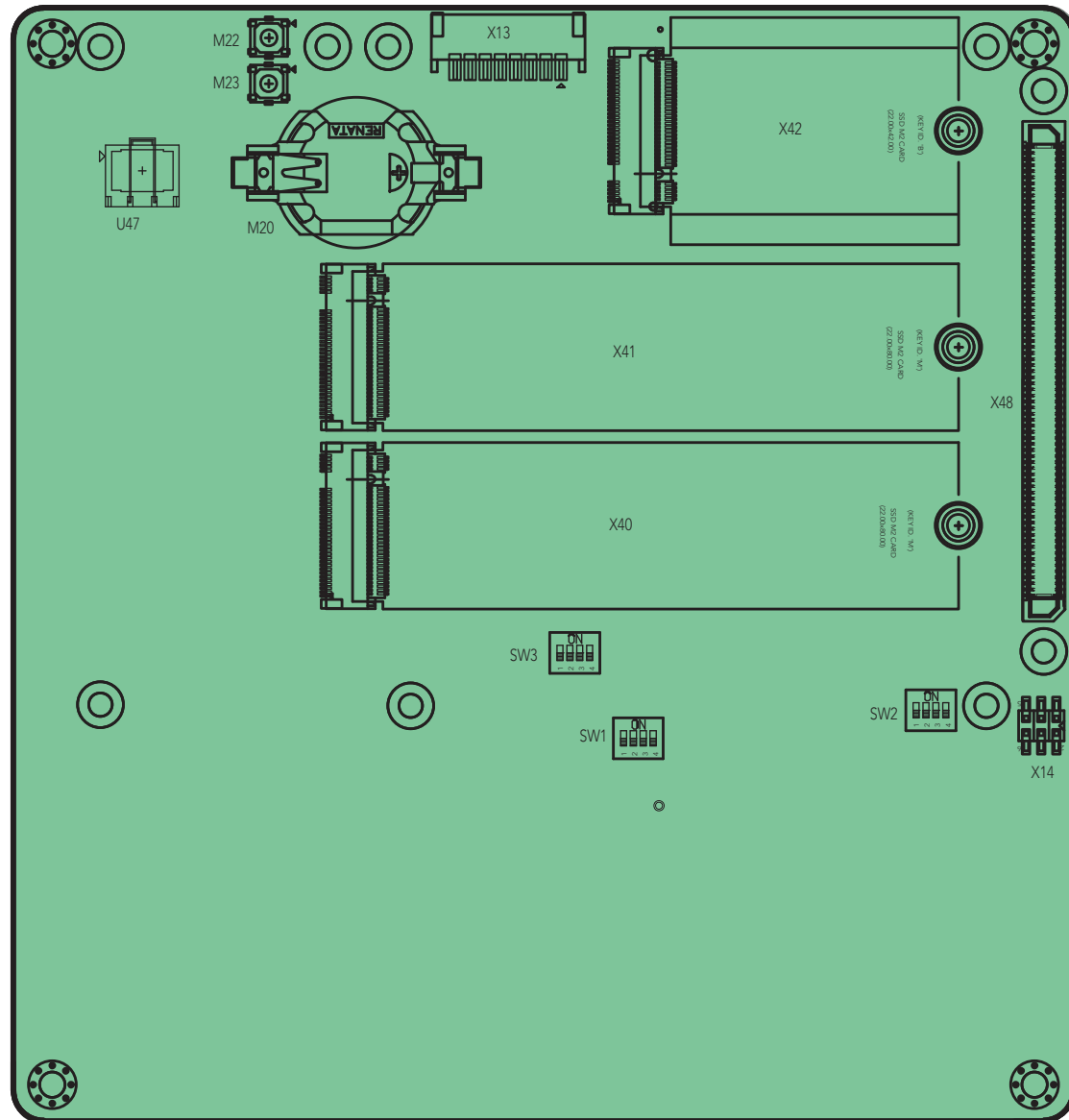



3 Specifications

3.1 Feature List

Table 1 Feature Summary

Form Factor	Based on Intel Mini-STX form factor (147 mm by 140 mm)	
Part Number	065450	
Supported Modules	congatec conga-B7E3 and conga-B7AC	
Operating Temperature Range	0°C to 60°C	
Ethernet	Gigabit Ethernet with support for: <ul style="list-style-type: none"> - 4x 10 Gb SFP+ (Inphy CS4227) - 3x 1 Gb RJ45 	
Board Management Controller	ASPEED AST2500	
Graphics	VGA from BMC	
Back Panel I/O Connectors	4x 10 Gbe SFP+ 3x 1 Gbe RJ45 ¹	2x USB 3.1 Gen 2 12 V DC input
Onboard I/O Connectors	1x Board to board PCIe x16 connector for add-on cards Extension Sockets: <ul style="list-style-type: none"> - 2x M.2 key M, type 2280 (PCIe x4/SATA) - 1x M.2 key B, type 3042 (PCIe x2/USB/I2C) ² COM Express Type 7 connectors 2x RS232 UART 1x Mini-Fit power connector	1x Feature connector (power button, reset,sleep, watchdog, GPIO, serial ports 0-1, SMB/I2C) 1x CPU fan 1x System fan 1x VGA (via the BMC) 1x SOIC8 for flashing external BIOS
IPMI	Baseboard Management Controller Intelligent Platform Interface 2.0 (IPMI 2.0) KVM, media redirection IPMI over LAN Serial over LAN	
Software	AMI Megarc SPX BMC firmware 32 MB serial SPI flash with congatec Embedded BIOS features	
Other Features	Buzzer Thermal and voltage monitoring CMOS Battery Boot from external BIOS flash	
Optional Features	BMC UART Status LEDs powered from S0	



Note

- 1. The GbE port X21 supports only BMC management (no support for network connectivity)*
- 2. Supports PCIe x1 if the module's gigabit Ethernet is enabled*

3.2 Mechanical Dimensions

The conga-STX7 has the following dimensions:

- length of 147 mm
- width of 140 mm
- height of 38.2 mm (30.8 mm top-side, 2 mm PCB and 5.4 mm bottom-side)

3.3 Supply Voltage Power

- 12 V DC \pm 10 %

3.4 Environmental Specifications

Temperature	Operation: 0°C to 60°C	Storage: -40° to +85°C (commercial temperature)
Humidity	Operation: 10% to 90%	Storage: 5% to 95%

Note

- 1. The above operating temperatures must be strictly adhered to at all times. The maximum operating temperature refers to any measurable spot on the modules surface.*
- 2. Humidity specifications are for non-condensing conditions.*
- 3. For long term storage of the conga-STX7 (more than six months), keep the conga-STX7 in a climate-controlled building at a constant temperature between 5°C and 40°C, with humidity of less than 65% and at an altitude of less than 3000 m. Also ensure the storage location is dry and well ventilated.*
- 4. We do not recommend storing the conga-STX7 for more than five years under these conditions.*



4 Connector Description

Table 2 Module Type 7 Connector Pinout—Rows A and B

Pin	Row A	Pin	Row B	Pin	Row A	Pin	Row B
A1	GND (FIXED)	B1	GND (FIXED)	A56	PCIE_TX4-	B56	PCIE_RX4-
A2	GBE0_MDI3-	B2	GBE0_ACT#	A57	GND	B57	GPO2
A3	GBE0_MDI3+	B3	LPC_FRAME#/ESPI_CS0#	A58	PCIE_TX3+	B58	PCIE_RX3+
A4	GBE0_LINK100#	B4	LPC_AD0/ESPI_IO_0	A59	PCIE_TX3-	B59	PCIE_RX3-
A5	GBE0_LINK1000#	B5	LPC_AD1/ESPI_IO_1	A60	GND (FIXED)	B60	GND (FIXED)
A6	GBE0_MDI2-	B6	LPC_AD2/ESPI_IO_2	A61	PCIE_TX2+	B61	PCIE_RX2+
A7	GBE0_MDI2+	B7	LPC_AD3/ESPI_IO_3	A62	PCIE_TX2-	B62	PCIE_RX2-
A8	GBE0_LINK#	B8	LPC_DRQ0#/ESPI_ALERT0#	A63	GPI1	B63	GPO3
A9	GBE0_MDI1-	B9	LPC_DRQ1#/ESPI_ALERT1#	A64	PCIE_TX1+	B64	PCIE_RX1+
A10	GBE0_MDI1+	B10	LPC_CLK/ESPI_CK	A65	PCIE_TX1-	B65	PCIE_RX1-
A11	GND(FIXED)	B11	GND (FIXED)	A66	GND	B66	WAKE0#
A12	GBE0_MDI0-	B12	PWRBTN#	A67	GPI2	B67	WAKE1# ²
A13	GBE0_MDI0+	B13	SMB_CK	A68	PCIE_TX0+	B68	PCIE_RX0+
A14	GBE0_CTREF	B14	SMB_DAT	A69	PCIE_TX0-	B69	PCIE_RX0-
A15	SUS_S3#	B15	SMB_ALERT#	A70	GND (FIXED)	B70	GND (FIXED)
A16	SATA0_TX+	B16	SATA1_TX+	A71	PCIE_TX8+	B71	PCIE_RX8+
A17	SATA0_TX-	B17	SATA1_TX-	A72	PCIE_TX8-	B72	PCIE_RX8-
A18	SUS_S4#	B18	SUS_STAT#/ESPI_RESET#	A73	GND	B73	GND
A19	SATA0_RX+	B19	SATA1_RX+	A74	PCIE_TX9+	B74	PCIE_RX9+
A20	SATA0_RX-	B20	SATA1_RX-	A75	PCIE_TX9-	B75	PCIE_RX9-
A21	GND (FIXED)	B21	GND (FIXED)	A76	GND	B76	GND
A22	PCIE_TX15+ ¹	B22	PCIE_RX15+ ¹	A77	PCIE_TX10+	B77	PCIE_RX10+
A23	PCIE_TX15- ¹	B23	PCIE_RX15- ¹	A78	PCIE_TX10-	B78	PCIE_RX10-
A24	SUS_S5#	B24	PWR_OK	A79	GND	B79	GND
A25	PCIE_TX14+ ¹	B25	PCIE_RX14+ ¹	A80	GND (FIXED)	B80	GND (FIXED)
A26	PCIE_TX14- ¹	B26	PCIE_RX14- ¹	A81	PCIE_TX11+	B81	PCIE_RX11+
A27	BATLOW#	B27	WDT	A82	PCIE_TX11-	B82	PCIE_RX11-
A28	(S)ATA_ACT#	B28	RSVD ¹	A83	GND	B83	GND
A29	RSVD ¹	B29	RSVD ¹	A84	NCSI_TX_EN	B84	VCC_5V_SBY



Pin	Row A	Pin	Row B	Pin	Row A	Pin	Row B
A30	RSVD ¹	B30	RSVD ¹	A85	GPI3	B85	VCC_5V_SBY
A31	GND (FIXED)	B31	GND (FIXED)	A86	RSVD ¹	B86	VCC_5V_SBY
A32	RSVD ¹	B32	SPKR	A87	RSVD ¹	B87	VCC_5V_SBY
A33	RSVD ¹	B33	I2C_CK	A88	PCIE_CK_REF+	B88	BIOS_DIS1#
A34	BIOS_DIS0#/ESPI_SAFS	B34	I2C_DAT	A89	PCIE_CK_REF-	B89	NCSI_RX_ER ²
A35	THRMTRIP#	B35	THRM#	A90	GND (FIXED)	B90	GND (FIXED)
A36	PCIE_TX13+ ¹	B36	PCIE_RX13+ ¹	A91	SPI_POWER	B91	NCSI_CLK_IN
A37	PCIE_TX13- ¹	B37	PCIE_RX13- ¹	A92	SPI_MISO	B92	NCSI_RXD1
A38	GND	B38	GND	A93	GPO0	B93	NCSI_RXD0
A39	PCIE_TX12+ ¹	B39	PCIE_RX12+ ¹	A94	SPI_CLK	B94	NCSI_CRS_DV
A40	PCIE_TX12- ¹	B40	PCIE_RX12- ¹	A95	SPI_MOSI	B95	NCSI_TXD1
A41	GND (FIXED)	B41	GND (FIXED)	A96	TPM_PP ²	B96	NCSI_TXD0
A42	USB2-	B42	USB3-	A97	TYPE10#	B97	SPI_CS#
A43	USB2+	B43	USB3+	A98	SER0_TX	B98	NCSI_ARB_IN ²
A44	USB_2_3_OC# ²	B44	USB_0_1_OC#	A99	SER0_RX	B99	NCSI_ARB_OUT ²
A45	USB0-	B45	USB1-	A100	GND (FIXED)	B100	GND (FIXED)
A46	USB0+	B46	USB1+	A101	SER1_TX	B101	FAN_PWMOUT
A47	VCC_RTC	B47	ESPI_EN#	A102	SER1_RX	B102	FAN_TACHIN
A48	RSVD ¹	B48	USB0_HOST_PRSENT ¹	A103	LID#	B103	SLEEP#
A49	GBE0_SDP ¹	B49	SYS_RESET#	A104	VCC_12V	B104	VCC_12V
A50	LPC_SERIRQ/ESPI_CS1#	B50	CB_RESET#	A105	VCC_12V	B105	VCC_12V
A51	GND (FIXED)	B51	GND (FIXED)	A106	VCC_12V	B106	VCC_12V
A52	PCIE_TX5+	B52	PCIE_RX5+	A107	VCC_12V	B107	VCC_12V
A53	PCIE_TX5-	B53	PCIE_RX5-	A108	VCC_12V	B108	VCC_12V
A54	GPI0	B54	GPO1	A109	VCC_12V	B109	VCC_12V
A55	PCIE_TX4+	B55	PCIE_RX4+	A110	GND (FIXED)	B110	GND (FIXED)

**Note**

¹. Not connected

². Not supported



Table 3 Module Type 7 Connector Pinout—Rows C and D

Pin	Row C	Pin	Row D	Pin	Row C	Pin	Row D
C1	GND (FIXED)	D1	GND (FIXED)	C56	PCIE_RX17-	D56	PCIE_TX17-
C2	GND	D2	GND	C57	TYPE1#	D57	TYPE2#
C3	USB_SSRX0-	D3	USB_SSTX0-	C58	PCIE_RX18+	D58	PCIE_TX18+
C4	USB_SSRX0+	D4	USB_SSTX0+	C59	PCIE_RX18-	D59	PCIE_TX18-
C5	GND	D5	GND	C60	GND (FIXED)	D60	GND (FIXED)
C6	USB_SSRX1-	D6	USB_SSTX1-	C61	PCIE_RX19+	D61	PCIE_TX19+
C7	USB_SSRX1+	D7	USB_SSTX1+	C62	PCIE_RX19-	D62	PCIE_TX19-
C8	GND	D8	GND	C63	RSVD	D63	RSVD
C9	USB_SSRX2-	D9	USB_SSTX2-	C64	RSVD	D64	RSVD
C10	USB_SSRX2+	D10	USB_SSTX2+	C65	PCIE_RX20+	D65	PCIE_TX20+
C11	GND(FIXED)	D11	GND (FIXED)	C66	PCIE_RX20-	D66	PCIE_TX20-
C12	USB_SSRX3-	D12	USB_SSTX3-	C67	RAPID_SHUTDOWN	D67	GND
C13	USB_SSRX3+	D13	USB_SSTX3+	C68	PCIE_RX21+	D68	PCIE_TX21+
C14	GND	D14	GND	C69	PCIE_RX21-	D69	PCIE_TX21-
C15	10G_PHY_MDC_SCL3	D15	10G_PHY_MDIO_SDA3	C70	GND (FIXED)	D70	GND (FIXED)
C16	10G_PHY_MDC_SCL2	D16	10G_PHY_MDIO_SDA2	C71	PCIE_RX22+	D71	PCIE_TX22+
C17	10G_SDP2 ²	D17	10G_SDP3 ²	C72	PCIE_RX22-	D72	PCIE_TX22-
C18	GND	D18	GND	C73	GND	D73	GND
C19	PCIE_RX6+	D19	PCIE_TX6+	C74	PCIE_RX23+	D74	PCIE_TX23+
C20	PCIE_RX6-	D20	PCIE_TX6-	C75	PCIE_RX23-	D75	PCIE_TX23-
C21	GND (FIXED)	D21	GND (FIXED)	C76	GND	D76	GND
C22	PCIE_RX7+	D22	PCIE_TX7+	C77	RSVD	D77	RSVD
C23	PCIE_RX7-	D23	PCIE_TX7-	C78	PCIE_RX24+	D78	PCIE_TX24+
C24	10G_INT2	D24	10G_INT3	C79	PCIE_RX24-	D79	PCIE_TX24-
C25	GND	D25	GND	C80	GND (FIXED)	D80	GND (FIXED)
C26	10G_KR_RX3+	D26	10G_KR_TX3+	C81	PCIE_RX25+	D81	PCIE_TX25+
C27	10G_KR_RX3-	D27	10G_KR_TX3-	C82	PCIE_RX25-	D82	PCIE_TX25-
C28	GND	D28	GND	C83	RSVD	D83	RSVD
C29	10G_KR_RX2+	D29	10G_KR_TX2+	C84	GND	D84	GND
C30	10G_KR_RX2-	D30	10G_KR_TX2-	C85	PCIE_RX26+	D85	PCIE_TX26+
C31	GND (FIXED)	D31	GND (FIXED)	C86	PCIE_RX26-	D86	PCIE_TX26-
C32	10G_SFP_SDA3	D32	10G_SFP_SCL3	C87	GND	D87	GND



Pin	Row C	Pin	Row D	Pin	Row C	Pin	Row D
C33	10G_SFP_SDA2	D33	10G_SFP_SCL2	C88	PCIE_RX27+	D88	PCIE_TX27+
C34	10G_PHY_RST_23	D34	10G_PHY_CAP_23	C89	PCIE_RX27-	D89	PCIE_TX27-
C35	10G_PHY_RST_01	D35	10G_PHY_CAP_01	C90	GND (FIXED)	D90	GND (FIXED)
C36	10G_LED_SDA	D36	RSVD	C91	PCIE_RX28+	D91	PCIE_TX28+
C37	10G_LED_SCL	D37	RSVD	C92	PCIE_RX28-	D92	PCIE_TX28-
C38	10G_SFP_SDA1	D38	10G_SFP_SCL1	C93	GND	D93	GND
C39	10G_SFP_SDA0	D39	10G_SFP_SCL0	C94	PCIE_RX29+	D94	PCIE_TX29+
C40	10G_SDP0 ²	D40	10G_SDP1 ²	C95	PCIE_RX29-	D95	PCIE_TX29-
C41	GND (FIXED)	D41	GND (FIXED)	C96	GND	D96	GND
C42	10G_KR_RX1+	D42	10G_KR_TX1+	C97	RSVD	D97	RSVD
C43	10G_KR_RX1-	D43	10G_KR_TX1-	C98	PCIE_RX30+	D98	PCIE_TX30+
C44	GND	D44	GND	C99	PCIE_RX30-	D99	PCIE_TX30-
C45	10G_PHY_MDC_SCL1	D45	10G_PHY_MDIO_SDA1	C100	GND (FIXED)	D100	GND (FIXED)
C46	10G_PHY_MDC_SCL0	D46	10G_PHY_MDIO_SDA0	C101	PCIE_RX31+	D101	PCIE_TX31+
C47	10G_INT0	D47	10G_INT1	C102	PCIE_RX31-	D102	PCIE_TX31-
C48	GND	D48	GND	C103	GND	D103	GND
C49	10G_KR_RX0+	D49	10G_KR_TX0+	C104	VCC_12V	D104	VCC_12V
C50	10G_KR_RX0-	D50	10G_KR_TX0-	C105	VCC_12V	D105	VCC_12V
C51	GND (FIXED)	D51	GND(FIXED)	C106	VCC_12V	D106	VCC_12V
C52	PCIE_RX16+	D52	PCIE_TX16+	C107	VCC_12V	D107	VCC_12V
C53	PCIE_RX16-	D53	PCIE_TX16-	C108	VCC_12V	D108	VCC_12V
C54	TYPE0#	D54	RSVD	C109	VCC_12V	D109	VCC_12V
C55	PCIE_RX17+	D55	PCIE_TX17+	C110	GND (FIXED)	D110	GND (FIXED)

 **Note**

1. *Not connected*
2. *Not supported*



4.1 Power Supply Connectors

The conga-STX7 provides a DC power jack and a 4-pin Mini-Fit connector. The power input is protected by a 15A fuse.

4.1.1 DC Power Jack

The conga-STX7 provides a DC power jack X43. The power input is protected by a 15A fuse.

Table 4 X43 Pinout Description

Pin	Function
Inner Shell	+12 V \pm 10%
Outer Shell	GND



Connector Type

X43 : DC power jack, 2.5 x 5.5 mm diameter

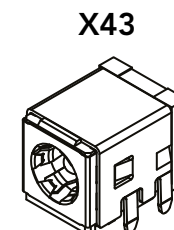

4.1.2 Mini-Fit 4-Pin Connector

The conga-STX7 provides an internal 4-pin Mini-Fit connector X44 with voltage protection.

Table 5 X44 Pinout Description

Pin	Signal	Description
1	GND	Ground
2	GND	Ground
3	+12 V	Power supply +12 V
4	+12 V	Power supply +12 V



Connector Type

X44 : 2 x 2-pin, 4.2 mm pitch Mini-Fit connector (Molex 87427-0442)

Possible Mating Connector: Molex 39012040

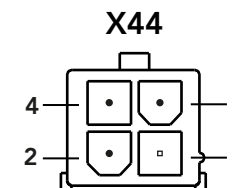



4.1.3 CMOS Battery Connector

The conga-STX7 provides battery holder M20 for attaching CR2032 CMOS battery. The battery supplies power to maintain the CMOS settings and real time clock.

Use jumper X31 to connect the RTC battery and jumper X49 to disconnect the RTC battery.

Table 6 X31/X49 Description

Jumper	Description
X31	Jumper connects RTC battery (default)
X49	Jumper disconnects the RTC battery

X31/X49



M20

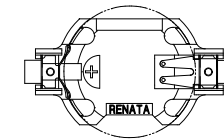

Warning

Danger of explosion if battery is incorrectly replaced. Replace only with the same or equivalent type recommended by the manufacturer. Dispose of used batteries according to the manufacturer's instructions.



Connector Type

X31, X49: 2.54mm, 1 x 2-pin header

4.1.4 Status LEDs

The table below describes the conga-STX7 status LEDs.

Table 7 Status LED Description

	LED	Color	Status	Description
Power	All		Off	No power applied to board and BMC
BMC Heatbeat	D1	Green	On (blinking)	BMC activity is detected. In BMC normal operation, the LED blinks at an interval of 0.5 s. Constant blinking indicates blank SPI ROM or abnormal operation.
			Off	BMC is not active
HDD	D30	Yellow	On (blinking)	Disk activity detected
			Off	No disk activity detected



SPF+ (10 GbE)	D4	Green	On	Network link for X15
	D7	Green	On	Network link for X17
	D10	Green	On	Network link for X18
	D13	Green	On	Network link for X20
	D45	Green	On	Network activity for X15
	D46	Green	On	Network activity for X17
	D47	Green	On	Network activity for X18
	D48	Green	On	Network activity for X20
LAN 1 (1 GbE)	Left	Orange/ Green	On	100 Mb or 1 Gb speed
	Right	Green	On (steady/blinking)	Link without activity/ Link established, activity detected
LAN 2 (1 GbE)	Left	Orange/ Green	On	100 Mb or 1 Gb speed
	Right	Green	On (steady/blinking)	Link without activity/ Link established, activity detected

4.2 Extension Sockets

The conga-STX7 provides three extension sockets:

- one M.2 key B, type 3042 (PCIe x2/USB/SIM)
- two M.2 key M, type 2280 (PCIe x4/SATA)

4.2.1 M.2 Key B Socket

The conga-STX7 provides an M.2 key B, type 3042 socket (X42) for connecting a PCIe or USB (WWAN) card.

Table 8 X42 Pinout Description

Pin	Signal	Pin	Signal
1	N.C	2	+3.3 V
3	GND	4	+3.3 V
5	GND	6	FULL_CARD_PWROFF#
7	USB_D+	8	W_DISABLE_1#
9	USB_D-	10	N.C

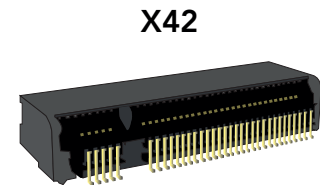



Pin	Signal	Pin	Signal
11	GND	12	Key
13	Key	14	
15		16	
17		18	
19		20	N.C
21	N.C	22	N.C
23	WoWWAN#	24	N.C
25	N.C	26	W_DISABLE_2#
27	GND	28	N.C
29	PCIe_Rx7-	30	N.C
31	PCIe_Rx7+	32	N.C
33	GND	34	N.C
35	PCIe_Tx7-	36	N.C
37	PCIe_Tx7+	38	DEVSLP
39	GND	40	N.C
41	PCIe_Rx6-	42	N.C
43	PCIe_Rx6+	44	N.C
45	GND	46	N.C
47	PCIe_Tx6-	48	N.C
49	PCIe_Tx6+	50	PERST#
51	GND	52	CLKREQ#
53	REFCLK-	54	PEWAKE#
55	REFCLK+	56	N.C
57	GND	58	N.C
59	N.C	60	N.C
61	N.C	62	N.C
63	N.C	64	N.C
65	N.C	66	N.C
67	RESET#	68	N.C
69	N.C	70	+3.3V
71	GND	72	+3.3V
73	GND	74	+3.3V
75	N.C		



Connector Type

X42: Standard PCIe M.2 key B socket

4.2.2 M.2 Key M Socket

The conga-STX7 provides two M.2 key M, type 2280 sockets (X40 and X41) for connecting PCIe x4 SSD (NVMe), SATA SSD or Intel® Optane™.

Table 9 X40/X41 Pinout Description

Pin	Signal	Pin	Signal
1	GND	2	+3.3V
3	GND	4	+3.3V
5	PCIe_Rx11- / PCIe_Rx3-	6	N.C
7	PCIe_Rx11+ / PCIe_Rx3+	8	N.C
9	GND	10	M2_SATA_LED#
11	PCIe_Tx11- / PCIe_Tx3-	12	+3.3V
13	PCIe_Tx11+ / PCIe_Tx3+	14	+3.3V
15	GND	16	+3.3V
17	PCIe_Rx10- / PCIe_Rx2-	18	+3.3V
19	PCIe_Rx10+ / PCIe_Rx2+	20	N.C
21	GND	22	N.C
23	PCIe_Tx10- / PCIe_Tx2-	24	N.C
25	PCIe_Tx10+ / PCIe_Tx2+	26	N.C
27	GND	28	N.C
29	PCIe_Rx9- / PCIe_Rx1-	30	N.C
31	PCIe_Rx9+ / PCIe_Rx1+	32	N.C
33	GND	34	N.C
35	PCIe_Tx9- / PCIe_Tx1-	36	N.C
37	PCIe_Tx9+ / PCIe_Tx1+	38	N.C
39	GND	40	N.C
41	PCIe_Rx8-/SATA1_Rx+ / PCIe_Rx0-/SATA0_Rx+	42	N.C
43	PCIe_Rx8+/SATA1_Rx- / PCIe_Rx0+/SATA0_Rx-	44	N.C
45	GND	46	N.C

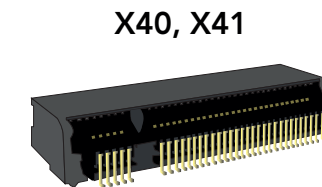



Pin	Signal	Pin	Signal
47	PCIe_Tx8-/SATA1_Tx+ / PCIe_Tx0-/SATA0_Tx+	48	N.C
49	PCIe_Tx8+/SATA1_Tx- / PCIe_Tx0+/SATA0_Tx-	50	PERST#
51	GND	52	CLKREQ#
53	REFCLK-	54	PEWAKE#/N.C
55	REFCLK+	56	N.C
57	GND	58	N.C
59	Key	60	Key
61		62	
63		64	
65		66	
67	N.C	68	N.C
69	PEDET	70	+3.3V
71	GND	72	+3.3V
73	GND	74	+3.3V
75	GND		

Connector Type

X40,X41: Standard PCIe M.2 key M socket

4.2.2.1 HDD LED Pin Header

The yellow LED D30 on the conga-STX7 glows when a SATA activity occurs on the M.2 key M socket. The conga-STX7 also provides pin header X39 for connecting external HDD LED.

Table 10 Header X39 Pinout Description

Pin	Signal
1	Anode
2	Cathode

Connector Type

X39: 2.54mm, 1 x 2-pin header

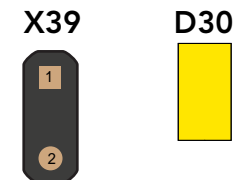



4.3 Board to Board Connector (PCIe x16)

The conga-STX7 provides a PCIe x16 board to board connector X48.

Table 11 X48 Pinout Description

Pin	Signal	Pin	Signal
1	GND	2	GND
3	SMB_CLK	4	WAKE#
5	SMB_DAT	6	3.3 VSB
7	GND	8	3.3 VSB
9	CLKREQ#	10	CB_RESET#
11	3.3 V	12	3.3 V
13	3.3 V	14	GND
15	3.3 V	16	GND
17	GND	18	PCIe0_CLK+
19	SUS_S3#	20	PCIe0_CLK-
21	GND	22	GND
23	GND	24	GND
25	PCIe_Tx16+	26	PCIe_Rx16+
27	PCIe_Tx16-	28	PCIe_Rx16-
29	GND	30	GND
31	GND	32	GND
33	PCIe_Tx17+	34	PCIe_Rx17+
35	PCIe_Tx17-	36	PCIe_Rx17-
37	GND	38	GND
39	GND	40	GND
41	PCIe_Tx18+	42	PCIe_Rx18+
43	PCIe_Tx18-	44	PCIe_Rx18-
45	GND	46	GND
47	GND	48	GND
49	PCIe_Tx19+	50	PCIe_Rx19+
51	PCIe_Tx19-	52	PCIe_Rx19-
53	GND	54	GND
55	GND	56	GND

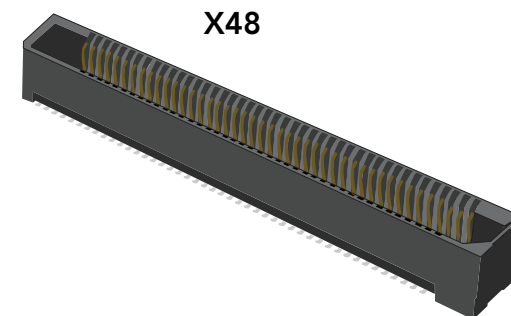



Pin	Signal	Pin	Signal
57	PCIe_Tx20+	58	PCIe_Rx20+
59	PCIe_Tx20-	60	PCIe_Rx20-
61	GND	62	GND
63	GND	64	GND
65	PCIe_Tx21+	66	PCIe_Rx21+
67	PCIe_Tx21-	68	PCIe_Rx21-
69	GND	70	GND
71	GND	72	GND
73	PCIe_Tx22+	74	PCIe_Rx22+
75	PCIe_Tx22-	76	PCIe_Rx22-
77	GND	78	GND
79	GND	80	GND
81	PCIe_Tx23+	82	PCIe_Rx23+
83	PCIe_Tx23-	84	PCIe_Rx23-
85	GND	86	GND
87	GND	88	GND
89	PCIe_Tx24+	90	PCIe_Rx24+
91	PCIe_Tx24-	92	PCIe_Rx24-
93	GND	94	GND
95	GND	96	GND
97	PCIe_Tx25+	98	PCIe_Rx25+
99	PCIe_Tx25-	100	PCIe_Rx25-
101	GND	102	GND
103	GND	104	GND
105	PCIe_Tx26+	106	PCIe_Rx26+
107	PCIe_Tx26-	108	PCIe_Rx26-
109	GND	110	GND
111	GND	112	GND
113	PCIe_Tx27+	114	PCIe_Rx27+
115	PCIe_Tx27-	116	PCIe_Rx27-
117	GND	118	GND
119	GND	120	GND
121	PCIe_Tx28+	122	PCIe_Rx28+



Pin	Signal	Pin	Signal
123	PCIe_Tx28-	124	PCIe_Rx28-
125	GND	126	GND
127	GND	128	GND
129	PCIe_Tx29+	130	PCIe_Rx29+
131	PCIe_Tx29-	132	PCIe_Rx29-
133	GND	134	GND
135	GND	136	GND
137	PCIe_Tx30+	138	PCIe_Rx30+
139	PCIe_Tx30-	140	PCIe_Rx30-
141	GND	142	GND
143	GND	144	GND
145	PCIe_Tx31+	146	PCIe_Rx31+
147	PCIe_Tx31-	148	PCIe_Rx31-
149	GND	150	GND



Note

Connector X48 is not available by default on conga-STX7 revision A.3.



Connector Type

X48: 2 x 75-pins high-speed socket (Samtec ERF8-075-05.0-S-DV-K-TR)

Possible Mating Connector: Samtec ERM8-075-09.0-S-DV-K-TR



4.4 PCI Express® Routing

The conga-STX7 PCIe lanes are routed as shown below.

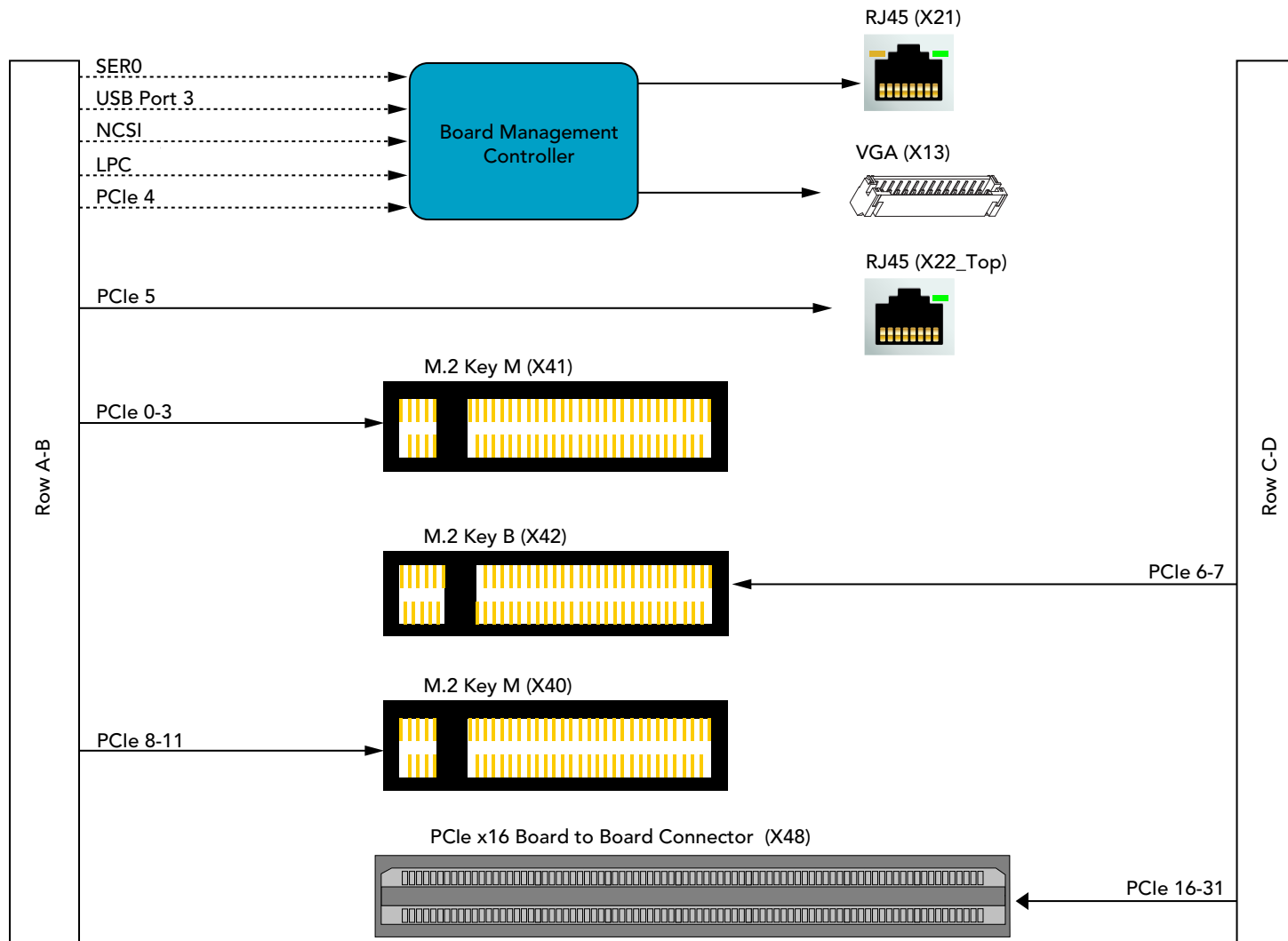



4.5 VGA Connector

The conga-STX7 provides a VGA header (X13) via the BMC—providing display capability without an additional cost for VGA add-on-card. The VGA controller in the BMC supports the following:

- resolution up to 1920x1200 @ 60Hz and 32 bpp
- widescreen resolutions:
 - WXGA: 1280 x 800, 32 / 16 bpp @ 60 Hz
 - WXGA+: 1440 x 900, 32 / 16 bpp @ 60 Hz
 - WSXGA+: 1680 x 1050, 32 / 16 bpp @ 60 Hz
 - FullHD: 1920 x 1080p 32 / 16 bpp @ 60 Hz
- VESA-compliant DDC interfaces for the display monitor
- hot-plug detection

The VGA controller controls the graphic output via PCIe lane 4.

Table 12 X13 Pinout Description

Pin	Signal
1	DDC_CLK
2	DDC_DAT
3	HSYNC
4	VSYNC
5	GND
6	BLUE
7	GREEN
8	RED

Connector Type

X13: 2 mm 8-pin socket (CHYAO_JS-1261R-08)

Possible Mating Connector: CHYAO_JS-1124-08

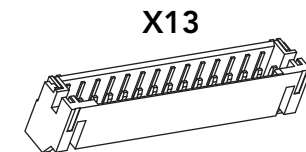



4.6 SFP+ (10 Gbe) Connector

The conga-STX7 offers four 10 GbE KR ports on connectors X15, X17, X18 and X20, enclosed in two EMI-shielded SFP+ cages (X16 and X19).

X15, X17, X18, X20

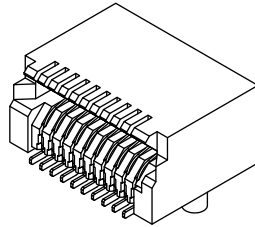

X16/X19

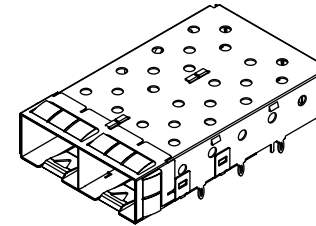

Connector Type

X15, X17, X18, X20: 20-pin SFP+ Connector

X16, X19: SFP+ 1 x 2 cage with EMI Shield

4.7 RJ45 (1 GbE) Connector

The conga-STX7 offers three RJ45 gigabit Ethernet connectors—a standard network interface from the module on X22 (upper slot), a standard network interface from the conga-STX7 on X22 (lower slot) and a BMC management interface on X21. The BMC management interface does not support network connectivity.

The status LEDs on X22 (lower slot) are powered from standby voltage by default. With assembly option, these status LEDs can be powered from main voltage S0.

Table 13 GbE Pinout Description

LED Left Side	Description	LED Right Side	Description
Off	10 Mbps link speed	Off	No link
Green	100 Mbps link speed	Steady On	Link established, no activity detected
Orange	1000 Mbps link speed	Blinking	Link established, activity detected

X21/X22

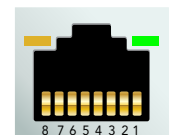

Connector Type

X21, X22: 8-pin RJ45 plug



4.7.1 PHY/MAC Management Headers

The conga-STX7 offers pin header X3 and X14 for managing the communication between the 10 GbE PHY on the carrier board and the MAC on the COM Express module.

Table 14 X3 Pinout Description

Pin	Signal
1	LAN1_MDC_SCL
2	LAN1_MDIO_SDA
3	LAN3_MDC_SCL
4	LAN3_MDIO_SDA

X3



Table 15 X14 Pinout Description

Pin	Signal	Pin	Signal
1	LAN0_MDC_SDA	2	LAN2_MDIO_SDA
3	GND	4	GND
5	LAN0_MDC_SCL	6	LAN2_MDIO_SCL

X14



Connector Type

X3: 2.54 mm, 1 x 4-pin header

X14: 2.5 mm, 2 x 3-pin header



4.8 USB Connector

The conga-STX7 provides two USB 3.1 Gen. 2 ports on connector X21. Each port supports a maximum current of 1 A.

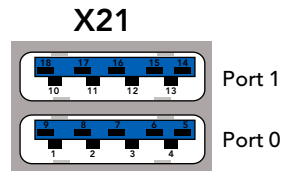

Connector Type

X21: RJ45 connector with dual-stacked USB 3.0 type A

4.9 UART Header

The conga-STX7 provides four UART ports:

- two RS232 UARTs from LPC to UART transceiver (X25 and X26)
- two General Purpose Serial Ports from the module (X32)

4.9.1 RS232 UART Header

The conga-STX7 provides two RS-232 compliant serial ports via pin headers X25 and X26. Both ports are sourced from an LPC to UART transceiver by default. With an assembly option, the UART signals on pin header X25 can be sourced from the BMC.

Use switch SW3 to configure the source of the UART signals.

Table 16 X25/X26 Pinout Description

Pin	Signal	Description	Pin	Signal	Description
1	DCD	Data Carrier Detect	2	DSR	Data Set Ready
3	RXD	Receive Data	4	RTS	Request to Send
5	TXD	Transmit Data/	6	CTS	Clear to Send
7	DTR	Data Terminal Ready	8	RI	Ring Indicator
9	GND	Ground	10	5 V	5 V supply

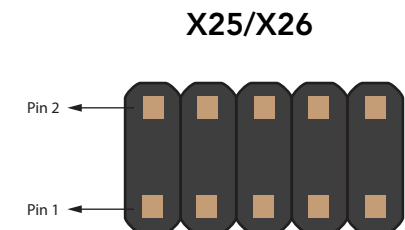



Table 17 Possible Serial Port Configuration

Configuration	LPC to UART Transceiver		COM Express
	X25	X26	X32
1	RS232 UART 0	RS232 UART 1	General Purpose Serial Port 0 and 1
2	BMC Debug UART (BOM option)	RS232 UART 1	General Purpose Serial Port 0

Table 18 SW3 Pinout Description

Switch	Configuration	Description
1 and 3	ON	Module UART to feature connector X32 (default)
2 and 4	OFF	
1 and 3	OFF	BMC Debug UART to pin header X25 (assembly option)
2 and 4	ON	



Connector Type

X25, X26: 2.54 mm, 2 x 5-pin header

SW3: DIP switch

4.9.2 General Purpose Serial Ports

The conga-STX7 provides two general purpose serial ports (SER0 and SER1) on the feature connector X32. The SER1 signals are routed to one of the following connectors:

- feature connector X32 (default)
- pin header X25, via the BMC (assembly option)

Use switch SW3 to route the module's SER1 port to the feature connector or to pin header X25.



Note

For X32 pinout description, see section 4.13 "Feature Connector".



4.10 Fan Header

The conga-STX7 provides two fan headers for connecting a 3-pin or 4-pin 12 V fan:

- CPU fan header (X36)
- System fan header (X38)

The COM Express module controls the speed of the the CPU fan X36 while the BMC controls the speed of the system fan X38. The recommended maximum power rating for the fans is 9 W.

Table 19 X36/X38 Pinout Description

Pin	Signal
1	GND
2	+12 VDC
3	FAN_TACHOIN
4	FAN_CTRL

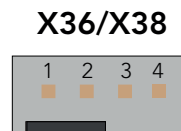

Note

1. The connector and pinout complies with 4-Wire Pulse PWM Controlled Fans Specification, Revision 1.3
2. FAN_TACHOIN fan output shall provide two pulses per revolution.
3. The fan must pull up the FAN_CTRL signal to high logic level

Connector Type

X36, X38: 2.54 mm, 4-pin grid fan connector

4.11 SPI Flash Socket

With conga-STX7, you can boot the COM Express module from either the COM module's onboard BIOS or from an external BIOS. The option to boot from an external BIOS is useful for evaluating a customized BIOS.

The conga-STX7 features an 8-pin SOIC8 socket U47 for attaching SPI flash. Use DIP switch M19 to select the flash device to boot from. The table below shows the available configurations.



Table 20 M19 Pinout Description

DIP Switch		Configuration
SW 1	SW 2	
OFF	OFF	Boot from on-module firmware (default)
OFF	ON	Not supported
ON	OFF	Boot from carrier board SPI Flash
ON	ON	Boot from on-module firmware, but load management data from carrier SPI

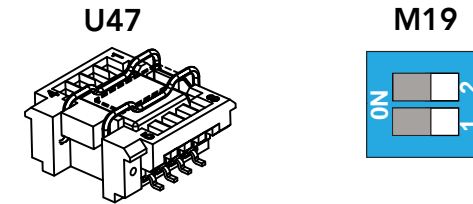

Connector Type

U47: SPI flash SOIC8 socket

M19: DIP switch

4.12 Front Panel Header

The conga-STX7 provides the following front panel headers:

- X50 for reset button
- X51 for power button
- X52 for power LED

Table 21 X50/X51/X52 Pinout Description

Pin	X50	X51	X52
1	SYS_RESET#	PWRBTN#	PWR_LED
2	GND	GND	GND

Connector Type

X50, X51, X52: 2.54mm, 1 x 2-pin header

X50/X51/X52





4.13 Feature Connector

The conga-STX7 provides feature connector X32. The pinout is described below:

Table 22 X32 Pinout Description

Pin	Signal Name	Pin Type	Voltage Level	Description
1	+5V	Power	5 V	+5V runtime power output (500 mA max).
2	GND	Ground		
3	LAD0	I/O	3.3 V	LPC command, address, data 0
4	LAD1	I/O	3.3 V	LPC command, address, data 1
5	LAD2	I/O	3.3 V	LPC command, address, data 2
6	LAD3	I/O	3.3 V	LPC command, address, data 3
7	LFRAME#	Output	3.3 V	LPC frame (start of cycle)
8	SERIRQ#	I/O	3.3 V	Serial Interrupt Request
9	LPC_CLK (24 MHz)	Output	3.3 V	24 MHz clock signal for external LPC device
10	PLT_RST#	Output	3.3 V standby	System reset, active low
11	SMB_DAT	I/OD	3.3 V standby	SMBus data
12	SMB_CLK	OD	3.3 V standby	SMBus clock output, up to 100 kHz
13	SMB_ALERT#	Input	3.3 V standby	SMBus alert (system wake or SMI), active low
14	GND			Ground
15	Tx_CGBC	Output	3.3 V standby	UART transmit port from congatec board controller (a debug port)
16	Rx_CGBC	Input	3.3 V standby	UART receive port from congatec board controller (a debug port)
17	GPO0	Output	3.3 V	General purpose output from module
18	GPO1	Output	3.3 V	General purpose output from module
19	GPO2	Output	3.3 V	General purpose output from module
20	GPO3	Output	3.3 V	General purpose output from module
21	SER0_Tx	Output	3.3 V	General purpose serial transmit port 0
22	N.C			Not connected
23	SER1_TX/BMC_Tx	Output	3.3 V	General purpose serial transmit port 1/BMC UART transmit
24	N.C			Not connected
25	GPI0	Input	3.3 V	General purpose input 0 to module
26	GPI1	Input	3.3 V	General purpose input1 to module
27	GPI2	Input	3.3 V	General purpose input 2 to module

X32





28	GPI3	Input	3.3 V	General purpose input 3 to module
29	SER0_Rx	Input	3.3 V	General purpose serial receive port 0
30	N.C			Not connected
31	SER1_Rx/BMC_Rx	Input	3.3 V	General purpose serial receive port 1/BMC UART receive
32	N.C			Not connected
33	SUS_S3#	Output	3.3 V standby	S3 sleep control (suspend to RAM), active low
34	SUS_S5#	Output	3.3 V standby	S5 sleep control (Soft Off), active low
35	SUS_S4#	Output	3.3 V standby	S4 sleep control (suspend to Disk), active low
36	LID_BTN#	Input	3.3 V standby	Connect directly to LID switch, active low
37	SLP_BTN#	Input	3.3 V standby	Connect directly to sleep button, active low
38	THRM#	Input	3.3 V	External thermal event, active low
39	WDOOUT	Output	3.3 V	Watchdog output event (module)
40	N.C			Not connected
41	I2C_DAT	I/OD	3.3 V standby	I2C data bus from module (general use)
42	PWR_OK (optional)	Input	VIN	Assembly option only (Power good signal from external PSU or voltage monitor)
43	SPI_CS#	Output	3.3V standby	SPI chip select for external SPI flash
44	I2C_CLK	OD	3.3V standby	I2C clock bus from module (general use)
45	SPI_MISO	Input	3.3V standby	External SPI flash data output
46	BIOS_DIS#	Input	3.3V standby	External SPI flash enable (boot from external SPI flash), active low
47	SPI_CLK	Output	3.3V standby	External SPI flash clock input
48	SPI_MOSI	Output	3.3V standby	External SPI flash data input
49	+5V standby	Power	5V standby	+5V standby power, 500mA max
50	GND	Ground		

Connector Type

X32: 2 mm, 2x25-pin header



5 BMC Overview

BMCs are used in servers for remote administration, thereby reducing the need for onsite administration of the servers. Some of the more common use cases are power cycling a server and monitoring fan speeds/ component temperatures, and hardware failures.

The conga-STX7 supports HTML5-based browsers for remote monitoring.

5.1 Firmware

The conga-STX7 features the AMI MegaRAC SP-X firmware. The firmware is a powerful software stack that sets the operating environment for the Board Management Controller. The firmware ensures that all the BMC management tasks defined by IPMI 2.0 as well as video redirection and remote monitoring using SoL or KVM over LAN are performed.

5.2 Features

Some of the features supported by the firmware are listed below:

- KVM/Media Redirection Support via BMC's video and USB
 - Redirection with H5View
 - Redirection with JViewer
- Media Redirection
 - CD redirection
 - Secure authentication and encryption for remote KVM, H5Viewer or JViewer
- Remote Server Power Control
 - Server's power status report
 - Support for server power-up, power-down, power cycle, reset and ACPI shutdown
- IPMI Message Interface Support via communication interfaces such as:
 - Keyboard Controller Style (KCS)
 - LAN (IPMI over LAN)
 - Serial interface (access through a serial port. Supports basic and terminal connection modes)



- IPMI Event Log and Alerting
 - Event logs reading
 - Sensor readings (3.3 V, 5 V, 5 VSB, 12 V and thermal sensors)
 - SNMP traps
 - Email alerts
 - LAN
- Web-based Configuration
 - Full configuration using GUI
 - Fail-safe BMC firmware upgrade
- SSH-based Serial Over LAN (SoL) ¹
 - Power control of the server
 - Complete command support
 - Dynamic target discovery
 - Firmware update
 - Role-based authentication and authorization
- IPMI chassis boot device manipulation ²
- BMC access via serial port (module's serial port 0), dedicated gigabit network controller or NC-SI ³ connection



Note

- ^{1.} *BIOS settings for SoL must be configured correctly*
- ^{2.} *Requires BIOS support*
- ^{3.} *NC-SI must be enabled on the COM Express module*



6 BMC Configuration and Management

The Intelligent Platform Management Interface is a system management interface that provides remote access, monitoring and administration over networks.

Before you can access the BMC, you need to set up and configure the conga-STX7 to support BMC features.

6.1 Before You Begin

1. Install the host Operating System ¹ on the conga-STX7.
2. Turn off the conga-STX7 after installation.
3. Insert the LAN cable plug to the BMC LAN port X21 or the 10 GbE ² cable to X15 or X17.

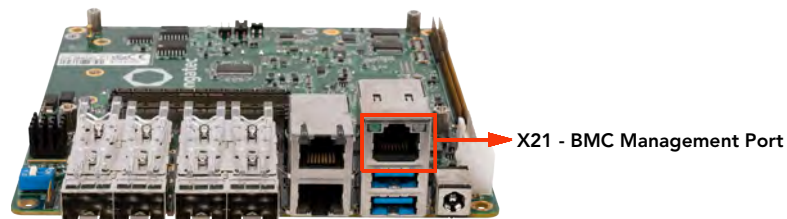

Note

- ¹ The BMC configuration examples in this document were tested on Ubuntu 18.04
- ² For remote management through ports X15 and X17, you need a 10 GbE LAN enabling kit to generate an image that supports NCSI. For more information, contact congatec technical support center or your local congatec sales representative.

6.2 Enable BMC Support in BIOS Setup Menu

1. Turn on the system.
2. During POST, press DELETE to enter the BIOS setup menu.
3. Navigate to Server Mgmt tab.
4. Scroll down to BMC Support and enable it.



6.3 BMC IP Address

The default IP address of the Server Management BMC LAN is 0.0.0.0. To control the BMC remotely, you need to configure the IP address of LAN channel 2 for DHCP or static addressing. You can do this in two ways:

- using the BIOS setup menu
- using the IPMI commands in Linux

6.3.1 Configure IP Using BIOS Setup Menu

1. Turn on the system.
2. During POST, press DELETE to enter the BIOS setup menu.
3. Navigate to the Server Mgmt tab .

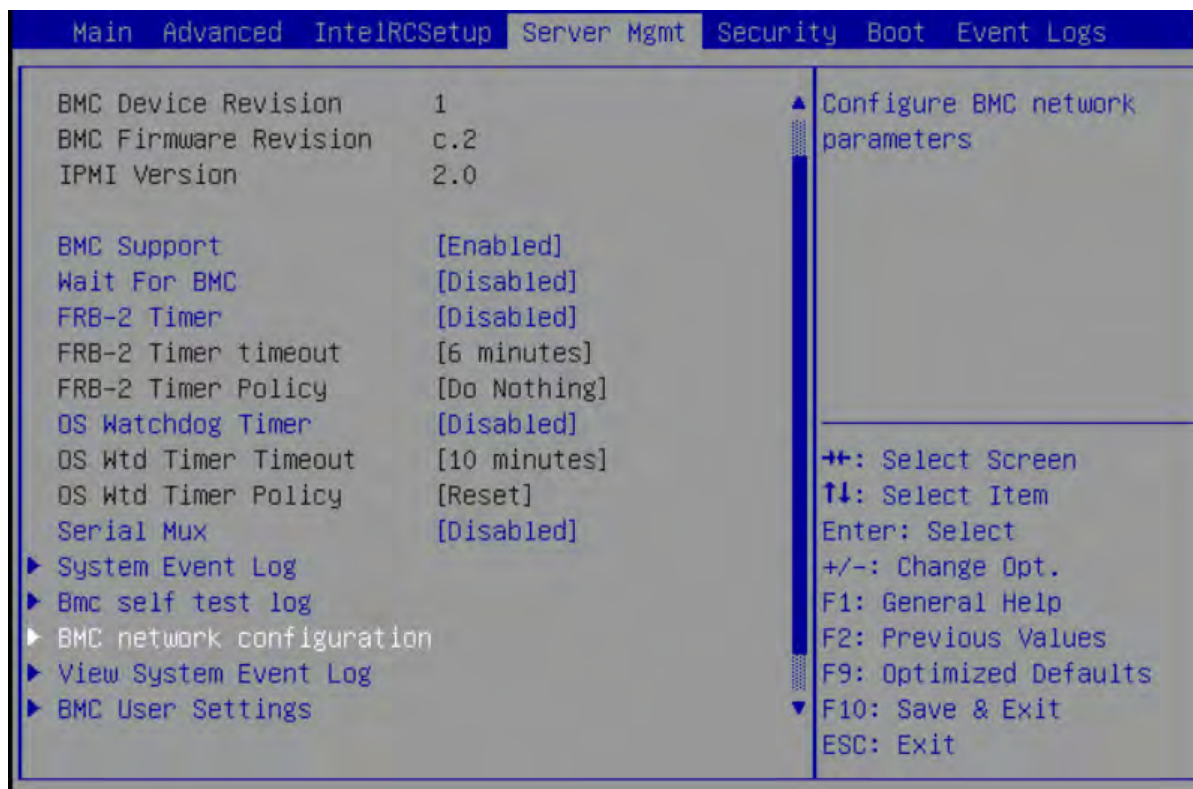



4. Scroll down to BMC Network Configuration and press Enter.
5. Under Lan channel 2, select Current Configuration Address Source.
6. Press Enter and then select Static or Dynamic Address.

```
Server Mgmt
Router IP address      0.0.0.0
Router MAC address    00-00-00-00-00-00

Lan channel 2
Configuration Address [Unspecified]
source
Current Configuration DynamicAddressBmcDhcp
Address source
Station IP address    10.11.9.148
Subnet mask           255.255.0.0
Station MAC address   00-13-95-3b-7a-bb
Router IP address     10.11.0.254
Router MAC address    00-09-0f-09-00-03

*****
Configure IPV6 support
*****

Select to configure LAN
channel parameters
statically or
dynamically(by BIOS or
BMC). Unspecified
option will not modify
any BMC network
parameters during BIOS

++: Select Screen
↑↓: Select Item
Enter: Select
+/-: Change Opt.
F1: General Help
F2: Previous Values
F9: Optimized Defaults
F10: Save & Exit
ESC: Exit
```

 **Note**

For static addressing, configure the IP address, subnet mask and gateway address. For dynamic addressing, the DHCP server assigns the addresses automatically after you restart the system.



7. Navigate to Save & Exit.
8. Select Save Changes and Exit and then press Enter to restart the system with new LAN settings.

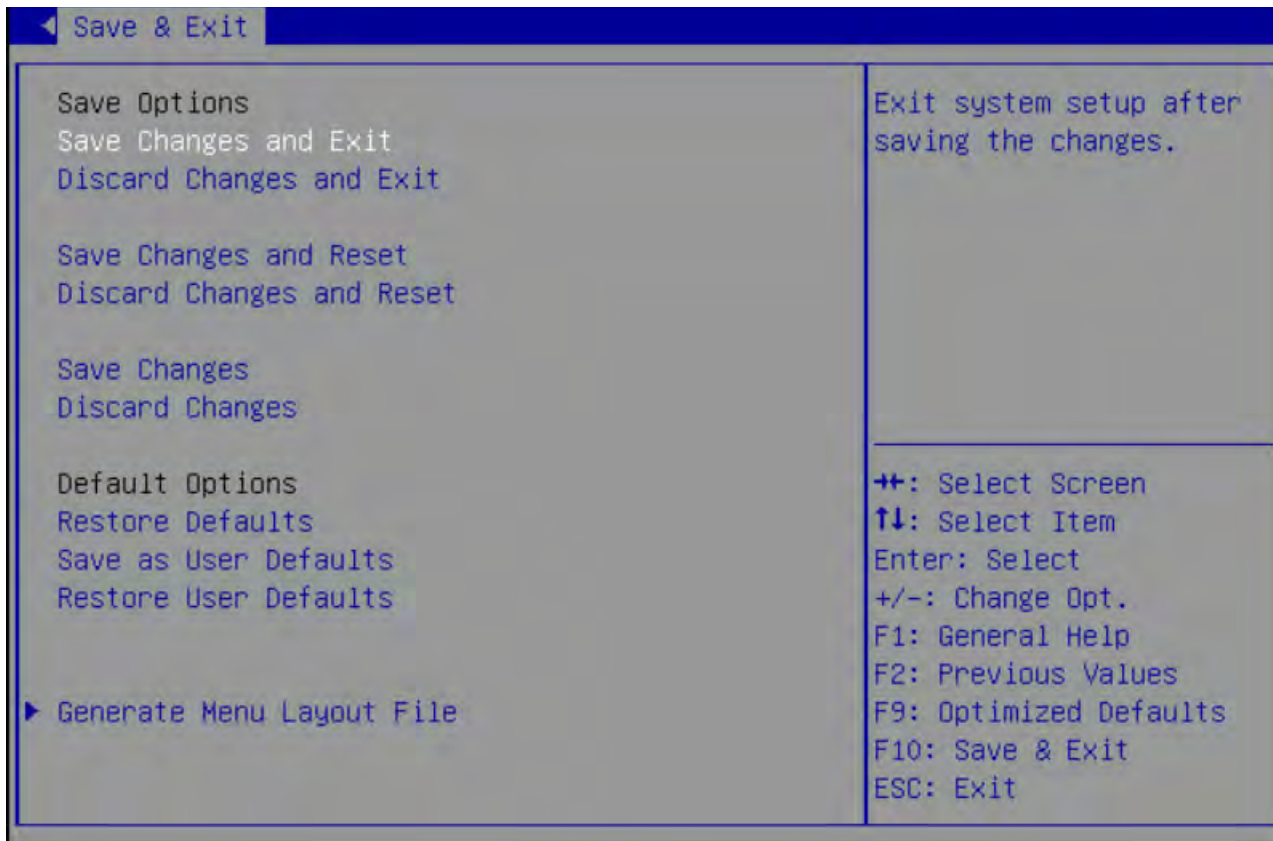

9. During POST, press DELETE to enter the BIOS setup menu.
10. Follow steps 2–4 above to view the assigned IP address.



6.3.2 Configure IP Using Ipmitool in Linux

1. Install "ipmitool" package

```
congatec@congatec-desktop:~$ sudo apt install ipmitool
```



Note

With ipmitool, you can view the firmware sensors or manipulate the boot devices without connecting a network cable to the BMC LAN. For more information, see section 7.1.2 "Local Access Using Ipmitool (Linux)".

2. Set the network addressing of channel 2 to DHCP or static. The example below sets DHCP addressing for channel 2.

```
congatec@congatec-desktop:~$ sudo ipmitool lan set 2 ipsrc dhcp
```

3. View the IP address of channel 2

```
congatec@congatec-desktop:~$ sudo ipmitool lan print 2
```



Note

You need this IP address for remote monitoring (BMC web interface).



7 BMC Access and Management

You can access and manage the BMC in the following ways:

- locally through the KCS system interface
- remotely through the LAN interface

7.1 Local BMC Management (KCS)

You can access and manage the BMC locally by using the BIOS Setup Menu or the Linux ipmitool tool.

7.1.1 Local Access Using BIOS Setup Menu

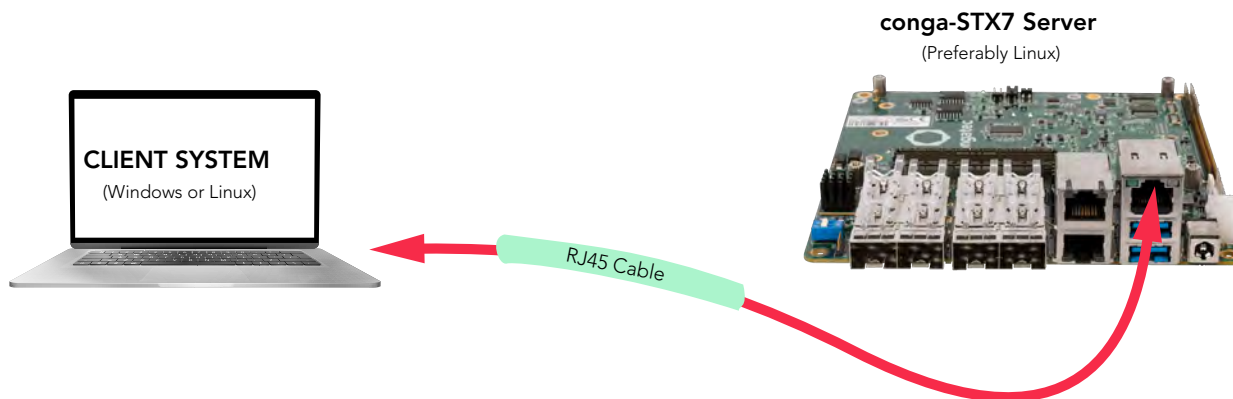

1. Plug one end of a LAN cable into the conga-STX7 BMC LAN port. Plug the other end into a Windows or Linux laptop (client).
2. Configure the client's TCP/IP network settings.
 - a. Set a static IP address. For example, 10.11.9.147.
 - b. Set the subnet address. For example, 255.255.0.0.



The gateway address is not required.



3. Configure the IP address of the conga-STX7 server.
 - a. Follow steps 1–6 of section 6.3.1 “Configure IP Using BIOS Setup Menu” to go to BMC IP Configuration section.
 - b. Assign a static IP address, for example, 10.11.9.148.
 - c. Assign the subnet address, for example, 255.255.0.0.
4. Both systems are now on the same subnet. On the client system, ping the conga-STX7 IP address to be sure it is reachable.
5. If ping is successful, open a web browser on the laptop and enter the IP address of the conga-STX7 server. You will be directed to the MegaRAC-SP login page. For instructions on how to log in, see section 7.2.1.2 “Logging In”.

7.1.2 Local Access Using Ipmitool (Linux)

The ipmitool is an open-source utility to monitor, configure and manage devices that support the Intelligent Platform Management Interface. The utility provides a command-line interface to the BMC.

With the ipmitool, you can:

- read the Sensor Data Repository and display the sensor values
- display the contents of the System Event Log
- set and print the LAN configuration parameters
- perform remote chassis power control

7.1.2.1 Test the Interface

The ipmitool command below checks if the KCS interface has been set up properly.

```
congatec@congatec-desktop:~$ sudo ipmitool -I open channel info
Channel 0xf info:
Channel Medium Type   : System Interface
Channel Protocol Type : KCS
Session Support       : session-less
Active Session Count  : 0
Protocol Vendor ID    : 7154
```



If the ipmi driver is not found, use 'sudo modprobe ipmi_devintf ipmi-si' to load the driver.



7.1.2.2 Sensor Readings

The ipmitool commands below displays the sensor information, including the sensor readings and status.

- summarized list of all sensors and their status

```
congatec@congatec-desktop:~$ sudo ipmitool sdr list
```

Thermal Sensor	35 degrees C	ok
5VSB	4.95 Volts	ok
12V	11.70 Volts	ok
5V	4.98 Volts	ok
3.3V	3.30 Volts	ok
SEL_sensor	0x00	ok
Watchdog2	0x00	ok
System Event	0x00	ok
Crit Interrupt	0x00	ok
AST2500	Dynamic MC @ 20h	ok

- comprehensive list of all sensors and their status

```
congatec@congatec-desktop:~$ sudo ipmitool sensor
```

Thermal Sensor	36.000	degrees C	ok	0.000	5.000	na	na	50.000	75.000
5VSB	4.950	Volts	ok	4.500	4.750	na	na	5.250	5.500
12V	11.800	Volts	ok	10.800	11.400	na	na	12.600	13.200
5V	4.975	Volts	ok	4.500	4.750	na	na	5.250	5.500
3.3V	3.300	Volts	ok	2.970	3.135	na	na	3.465	3.630
SEL_sensor	0x0	discrete	0x0080	na	na	na	na	na	na
Watchdog2	0x0	discrete	0x0080	na	na	na	na	na	na
System Event	0x0	discrete	0x0080	na	na	na	na	na	na
Crit Interrupt	0x0	discrete	0x0080	na	na	na	na	na	na



The sensor values displayed may vary slightly from the values measured by the congatec Board Controller.



7.1.2.3 System Event Log

The ipmitool commands below displays the system event log.

- list of all event entries:

```
congatec@congatec-desktop:~$ sudo ipmitool sel list
```

```
1 | 01/01/2012 | 00:31:47 | Event Logging Disabled #0x0d | Log area reset/cleared | Asserted
2 | 01/01/2012 | 00:39:43 | System Event #0x22 | Timestamp Clock Sync | Asserted
3 | 01/01/2012 | 00:39:43 | System Event #0x22 | Timestamp Clock Sync | Asserted
```

- detailed information of a specific event:

```
congatec@congatec-desktop:~$ sudo ipmitool sel get 1
```

```
SEL Record ID      : 0001
Record Type        : 02
Timestamp          : 01/01/2012 00:31:47
Generator ID       : 0020
EvM Revision       : 04
Sensor Type        : Event Logging Disabled
Sensor Number      : 0d
Event Type         : Sensor-specific Discrete
Event Direction    : Assertion Event
Event Data (RAW)   : 02ffff
Event Interpretation : Missing
Description        : Log area reset/cleared

Sensor ID          : SEL_sensor (0xd)
Entity ID          : 6.2
Sensor Type (Discrete): Event Logging Disabled
```

7.1.2.4 LAN Configuration Parameters

With the ipmitool, you can configure and view the IP network settings.

- configure the channel's network assignment as dynamic or static

- Dynamic network address for channel 2:

```
congatec@congatec-desktop:~$ sudo ipmitool lan set 2 dhcp
```

- static network address for channel 2:

```
congatec@congatec-desktop:~$ sudo ipmitool lan set 2 static
congatec@congatec-desktop:~$ sudo ipmitool lan set 2 ipaddr 10.11.9.149
```



```
Setting LAN IP Address to 10.11.9.149
congatec@congatec-desktop:~$ sudo ipmitool lan set 2 netmask 255.255.0.0
Setting LAN Subnet Mask to 255.255.0.0
congatec@congatec-desktop:~$ sudo ipmitool lan set 2 defgw ipaddr 10.11.0.254
Setting LAN Default Gateway IP to 10.11.0.254
```

- view network configuration settings of channel 2

```
congatec@congatec-desktop:~$ sudo ipmitool lan print 2
```

```
Set in Progress      : Set Complete
Auth Type Support    :
Auth Type Enable     : Callback : MD5
                    : User      : MD5
                    : Operator : MD5
                    : Admin   : MD5
                    : OEM    : MD5
IP Address Source    : Static Address
IP Address           : 10.11.9.149
Subnet Mask          : 255.255.0.0
MAC Address          : 00:13:95:3b:7a:bb
SNMP Community String : AMI
IP Header            : TTL=0x40 Flags=0x40 Precedence=0x00 TOS=0x10
BMC ARP Control      : ARP Responses Enabled, Gratuitous ARP Disabled
Gratuitous ARP Intrvl : 1.0 seconds
Default Gateway IP   : 10.11.0.254
Default Gateway MAC  : 00:09:0f:09:00:03
Backup Gateway IP    : 0.0.0.0
Backup Gateway MAC   : 00:00:00:00:00:00
802.1q VLAN ID       : Disabled
802.1q VLAN Priority : 0
RMCP+ Cipher Suites  : 0,1,2,3,6,7,8,11,12,15,16,17
Cipher Suite Priv Max : caaaaaaaaaXXX
                    : X=Cipher Suite Unused
                    : c=CALLBACK
                    : u=USER
                    : o=OPERATOR
                    : a=ADMIN
                    : O=OEM
Bad Password Threshold : 0
Invalid password disable: no
Attempt Count Reset Int.: 0
User Lockout Interval  : 0
```



7.1.2.5 Chassis Power Control

With "ipmitool chassis" command, you can view the power status of the conga-STX7 server. You can also power on or power down the server.

- view the conga-STX7 chassis status

```
congatec@congatec-desktop:~$ sudo ipmitool chassis status
```

```
System Power      : on
Power Overload    : false
Power Interlock   : inactive
Main Power Fault  : false
Power Control Fault : false
Power Restore Policy : always-on
Last Power Event  : ac-failed
Chassis Intrusion : inactive
Front-Panel Lockout : inactive
Drive Fault       : false
Cooling/Fan Fault : false
Sleep Button Disable : allowed
Diag Button Disable : allowed
Reset Button Disable : allowed
Power Button Disable : allowed
Sleep Button Disabled: false
Diag Button Disabled : false
Reset Button Disabled: false
Power Button Disabled: false
```

- start the conga-STX7 server

```
congatec@congatec-desktop:~$ sudo ipmitool chassis power on
Chassis Power Control: Up/On
```

- reset the conga-STX7 server

```
congatec@congatec-desktop:~$ sudo ipmitool chassis power cycle
Chassis Power Control: Cycle
```

- shut down the operating system gracefully and power off the conga-STX7 to standby power mode

```
congatec@congatec-desktop:~$ sudo ipmitool chassis power soft
Chassis Power Control: Soft
```

- power off the conga-STX7 server immediately from full power mode to standby power mode

```
congatec@congatec-desktop:~$ sudo ipmitool chassis power soft
Chassis Power Control: Soft
```



7.2 Remote BMC Management

You can access and manage the BMC remotely by using the BMC web interface, ipmitool in Linux or the Serial over LAN interface

7.2.1 Remote Access Using BMC Web Interface

Use the browser-based MegaRAC SP-X GUI to remotely monitor and configure the server.

7.2.1.1 Supported Browsers

The MegaRAC SP-X GUI supports the following browsers:

- Internet Explorer
- Windows Edge
- Firefox
- Safari
- Opera
- Google Chrome

7.2.1.2 Logging In

For first-time log in to the AMI MegaRAC SP-X GUI, you need the BMC IP address and the factory default username and password.

1. Open a supported browser.
2. Type the BMC IP address, for example, 10.11.9.149 and click Enter.

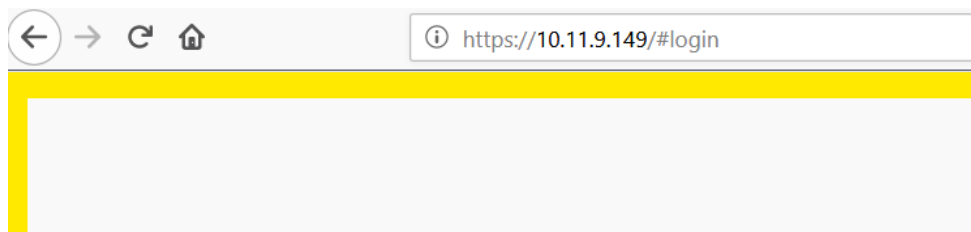



3. When the security warning appears, click **Advanced** to continue.

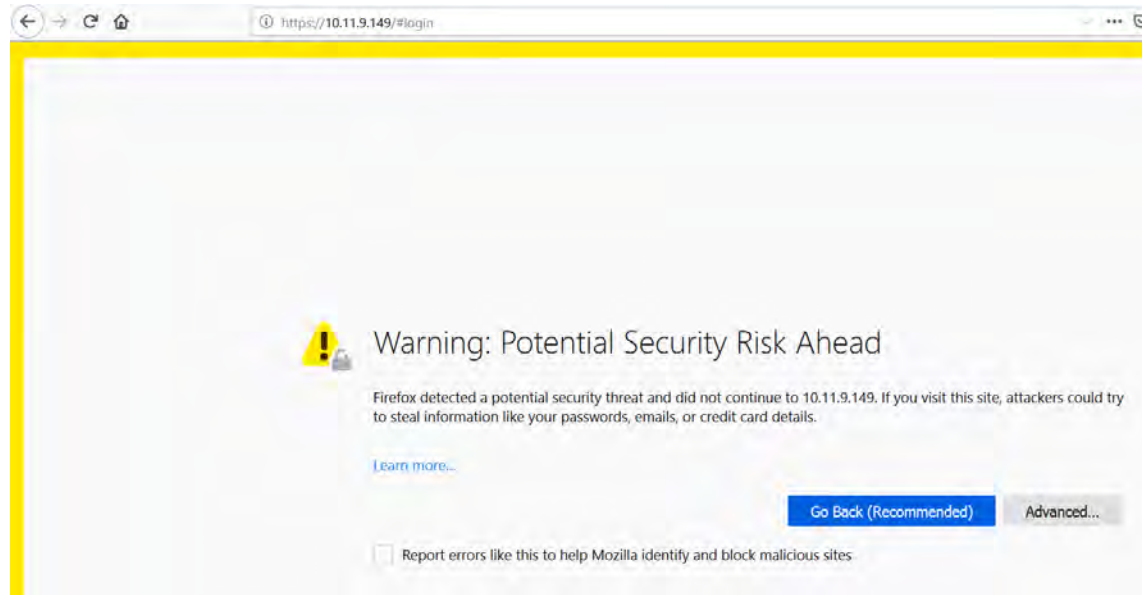

4. Click **Accept the Risk and Continue**.

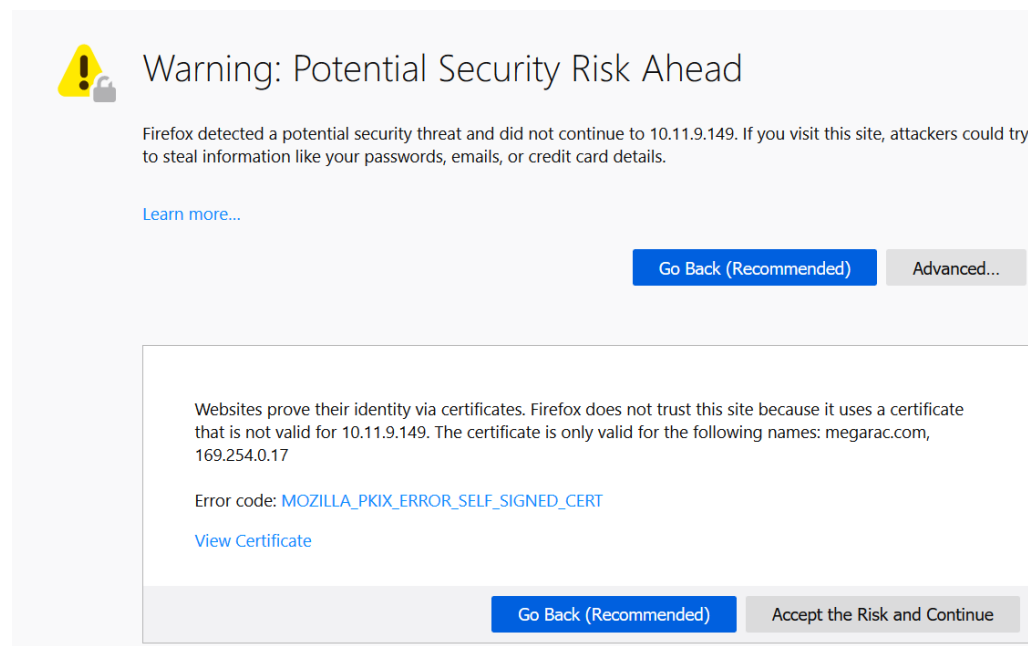



5. When the Login page appears, enter the default username and password.

Username: admin
Password: admin

MEGARAC SP-X

Username

Password

US - English

Remember Username

Sign me in

[I forgot my password](#)



For security reasons, change the username and password after the first login.

6. Click Sign me in to login.

MEGARAC SP-X

admin

•••••

US - English

Remember Username

Sign me in

[I forgot my password](#)



The MegaRAC SP-X main page displays.

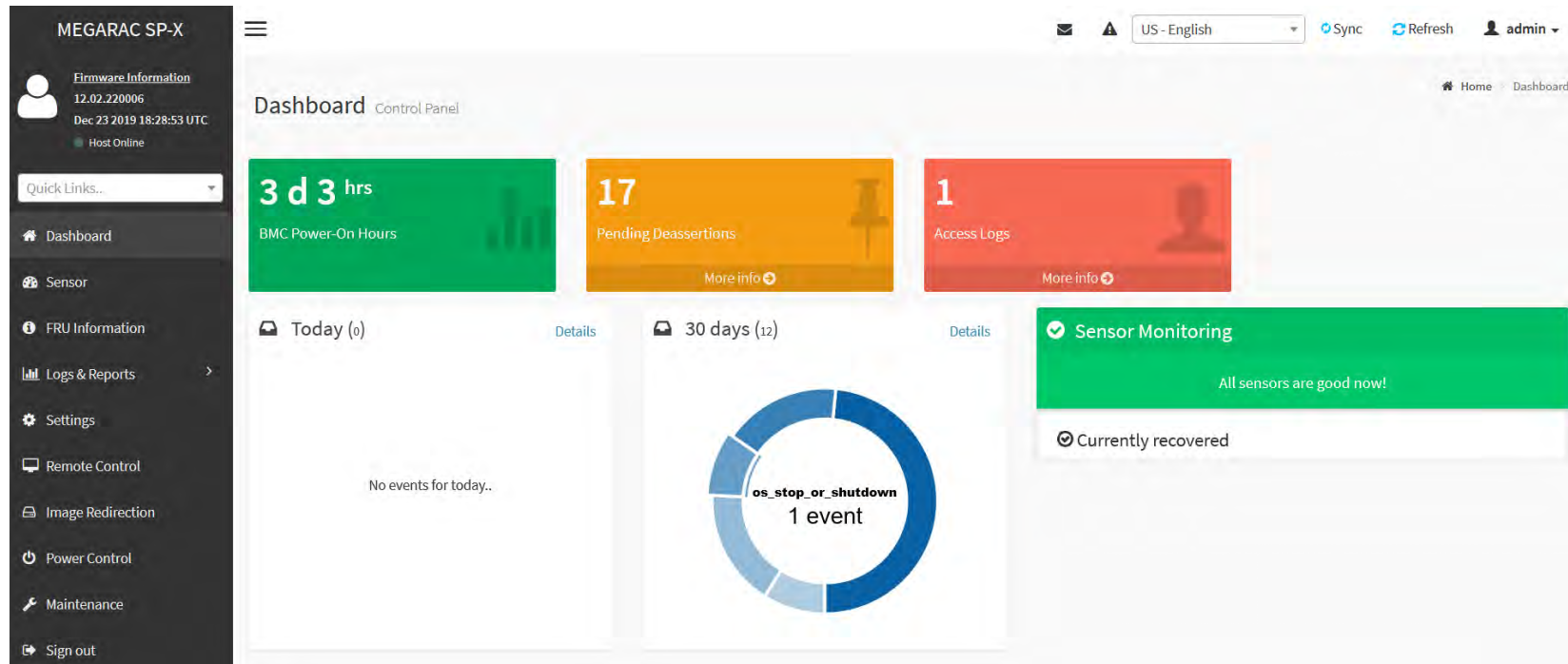

The table below describes the menu items of the MegaRAC SP-X main page.

Table 23 MegaRAC Menu Bar Description

Menu Item	Description
Dashboard	Displays the general information about the the status of the BMC
Sensor	Displays all sensor-related information
FRU Information	Displays the BMC Field Replaceable Unit file information Note:The conga-STX7 does not feature FRUs
Logs & Reports	Shows event logs and reports of the IPMI, system, audit and video
Settings	Displays the various configuration settings
Remote Control	Displays the H5Viewer and JViewer buttons for remote (KVM) control operation
Image Redirection	Allows the BMC to emulate and redirect remote images Note: To configure the image, you need to enable Remote Media support in Settings -> Media Redirection -> General Settings



Power Control	Displays the current power status and also options to power off, power on, power cycle, hard reset or shut down the remote system
Maintenance	Shows BMC firmware information and general firmware maintenance and system administration options
Sign out	Provides option to log out of the current MegaRAC session

7.2.1.3 KVM Remote Control Operation

The remote control allows you to do the following:

- control the conga-STX7 operating system remotely, using KVM over IP
- redirect local client CD or DVD images as a virtual device on the remote system
- reset, power cycle or shutdown the conga-STX7



Note

Use a primary (integrated) video device for remote control. The remote control operation will fail if you use an external video card.

Control Operating System Remotely

1. From the menu bar, click Remote Control.

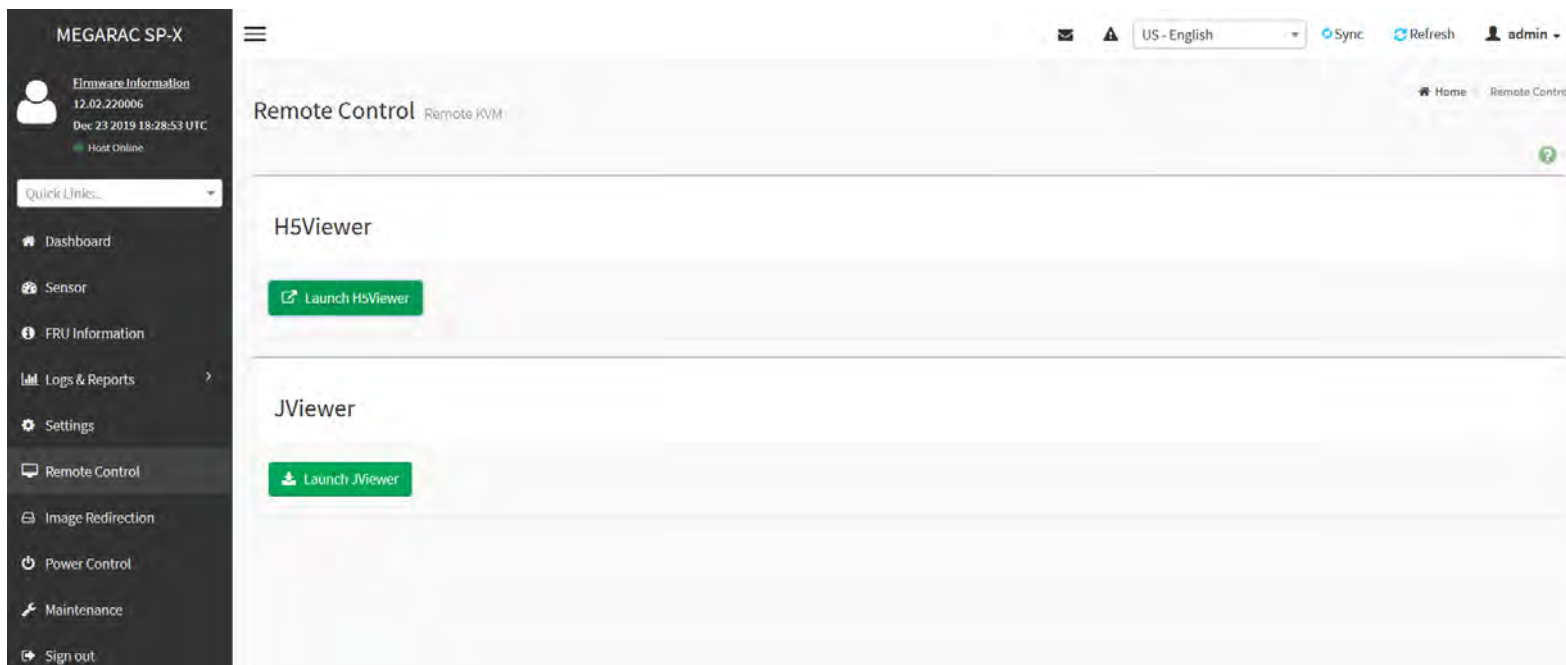



2. Click H5Viewer (or JViewer) button to access the conga-STX7 screen.

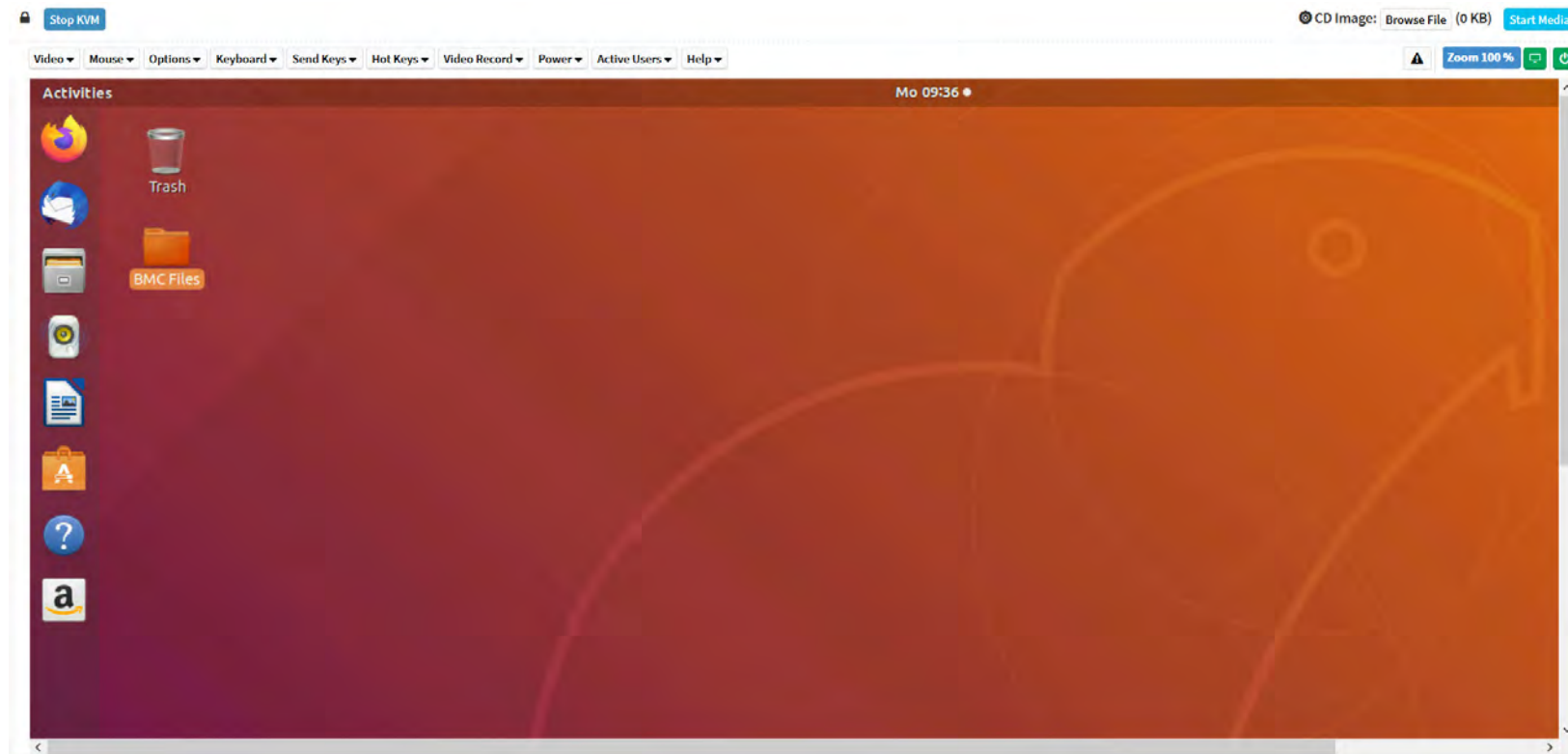

 **Note**

JViewer requires the installation of Java Runtime Environment plugin.



Redirect Local Media

1. At the upper right hand corner, click **Browse File** to open the file browser.

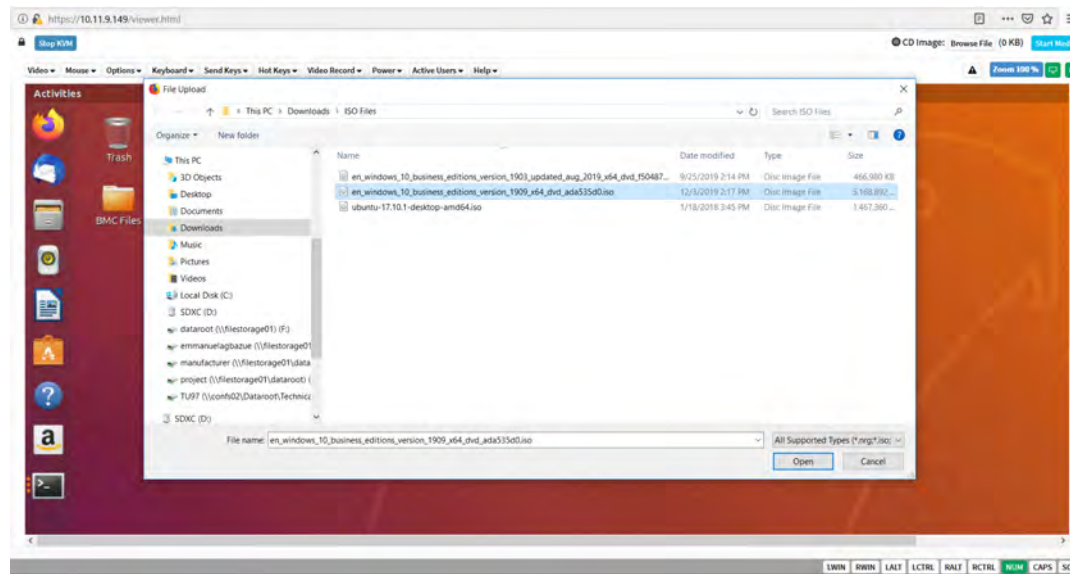

2. Navigate to a bootable image.
3. Select the image and click **open**.
4. Click **Start Media** at the upper right hand corner to mount the CD

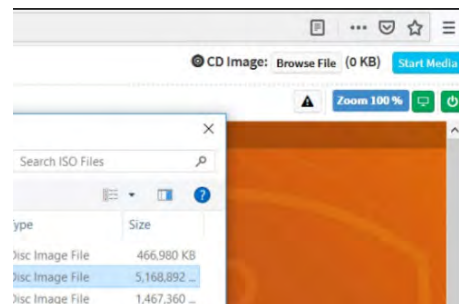



5. Click Power and then Power Cycle Server to restart the system.

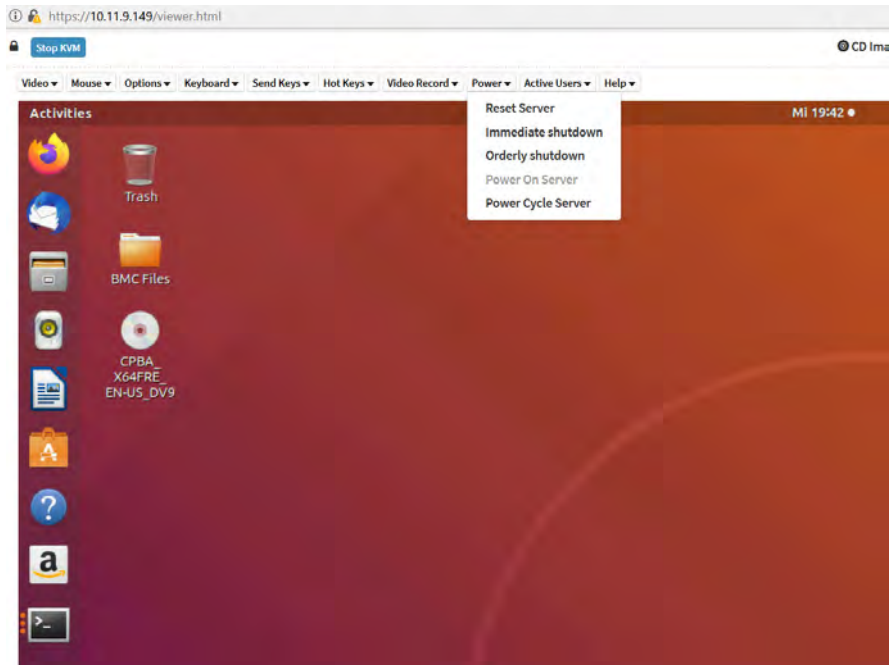

6. When the Power Cycle dialog box appears, click OK to restart.

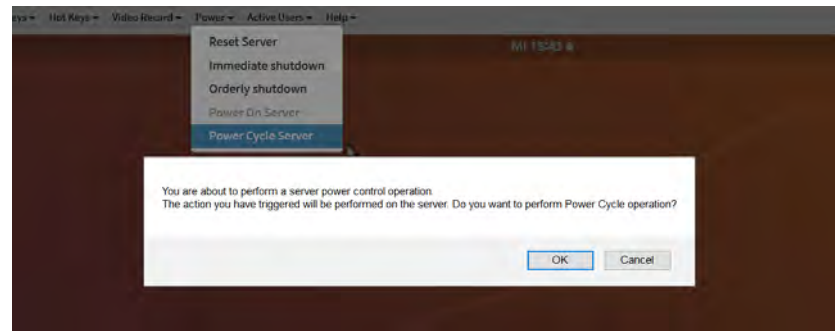



7. When the startup screen appears, press F11 to show the boot options.

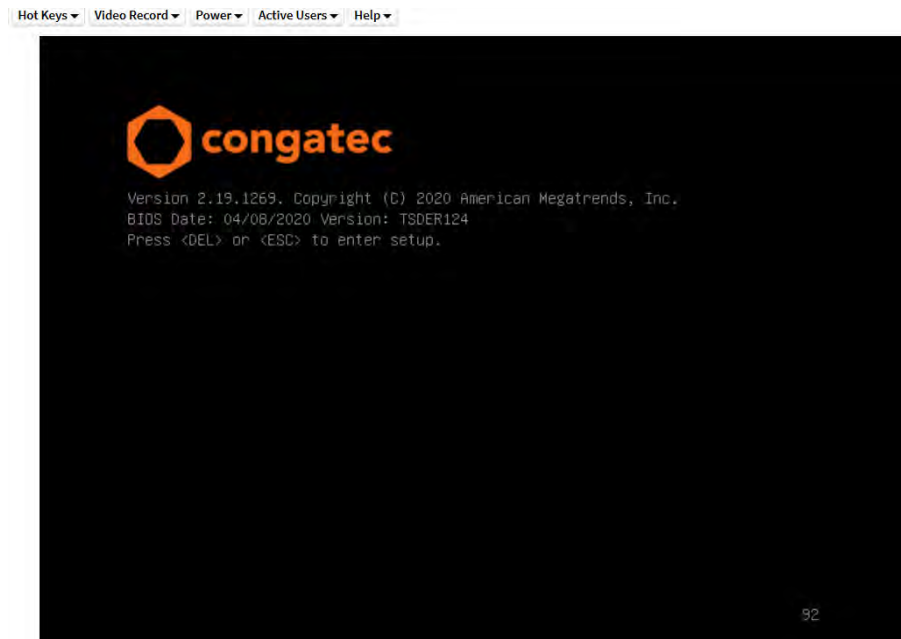

8. Select UEFI: AMI Virtual CDROM 0 1.00 with the UP ARROW key.





9. Press any key to start the installation

Remote KVM [10.11.9.149] - [1024 x 768] - Mozilla Firefox

https://10.11.9.149/viewer.html

Stop KVM CD Image: en_windows_10_business_editions_version_1909_x64_dvd_ada535d0.iso (529294 KB) Stop Media

Video Mouse Options Keyboard Send Keys Hot Keys Video Record Power Active Users Help

Zoom 100%

Windows Setup

Windows

Language to install: English (United States)

Time and currency format: English (United States)

Keyboard or input method: US

Enter your language and other preferences and click "Next" to continue.

© 2019 Microsoft Corporation. All rights reserved. Next

LWIN RWIN LALT LCTRL RALT RCTRL NUM CAPS SCR



7.2.2 Remote Access Using Ipmitool (Linux)

You can monitor and configure the server remotely using ipmitool in Linux. The ipmitool command for remote access supports all the features described in section 7.1.2 “Local Access Using Ipmitool (Linux)”

The format of the ipmitool command for remote access is:

```
sudo ipmitool -I lanplus -H <IP address> -U <Username> <IPMITool command> where:
```

-I = interface to use (examples are: open (default), imb, lan and lanplus)

-H = remote host name or IP address

-U = remote session username

Note: Default username = admin; default password = admin.

Sample commands are shown in the table below:

Table 24 Ipmitool Remote Commands

Configuration	Command	Description
LAN	sudo ipmitool -I open -H 10.11.9.149 -U admin lan print 2	Displays the IP address of channel 2
	sudo ipmitool -I open -H 10.11.9.149 -U admin lan set 2 ipsrc dhcp	Sets network addressing of channel 2 to dynamic
	sudo ipmitool -I open -H 10.11.9.149 -U admin lan set 2 ipsrc static	Sets network addressing of channel 2 to static
	sudo ipmitool -I open -H 10.11.9.149 -U admin lan set 2 ipaddr 10.11.9.149	Configures channel 2's IP address
	sudo ipmitool -I open -H 10.11.9.149 -U admin lan set 2 netmask 255.255.0.0	Configures channel 2's netmask
	sudo ipmitool -I open -H 10.11.9.149 -U admin lan set 2 defgw 10.11.0.254	Configures channel 2's default gateway
SDR	sudo ipmitool -I open -H 10.11.9.149 -U admin sdr list	Displays a list of all sensors and their status
	sudo ipmitool -I open -H 10.11.9.149 -U admin sdr elist	Displays extended sensor information
	sudo ipmitool -I open -H 10.11.9.149 -U admin sensor	Display sensors and threshold values
Power control	sudo ipmitool -I open -H 10.11.9.149 -U admin chassis status	Shows the status of the system
	sudo ipmitool -I open -H 10.11.9.149 -U admin power status	Displays the current power status
	sudo ipmitool -I open -H 10.11.9.149 -U admin power cycle	Restarts the system
	sudo ipmitool -I open -H 10.11.9.149 -U admin power on	Turn on the system
	sudo ipmitool -I open -H 10.11.9.149 -U admin power soft	Gracefully put the system to standby mode
	sudo ipmitool -I open -H 10.11.9.149 -U admin power off	Turn off the system
Event Log	sudo ipmitool -I open -H 10.11.9.149 -U admin sel	Displays event log information
	sudo ipmitool -I open -H 10.11.9.149 -U admin sel list	Displays list of all event entries
	sudo ipmitool -I open -H 10.11.9.149 -U admin sel elist	Displays an extended list of all events
	sudo ipmitool -I open -H 10.11.9.149 -U admin sel clear	Clears the event log list



7.2.3 Using Serial Over LAN (SoL)

The BMC allows remote monitoring using Serial over LAN—a text-based console redirection. This feature provides serial port connections over LAN to allow the user to access, monitor and manage a server remotely via console redirection.

7.2.3.1 SoL Configuration

Follow the steps below to configure the conga-STX7 for Serial over LAN.

1. Turn on the system.
2. During POST, press DELETE to enter the BIOS setup menu.
3. Navigate to the Advanced tab.

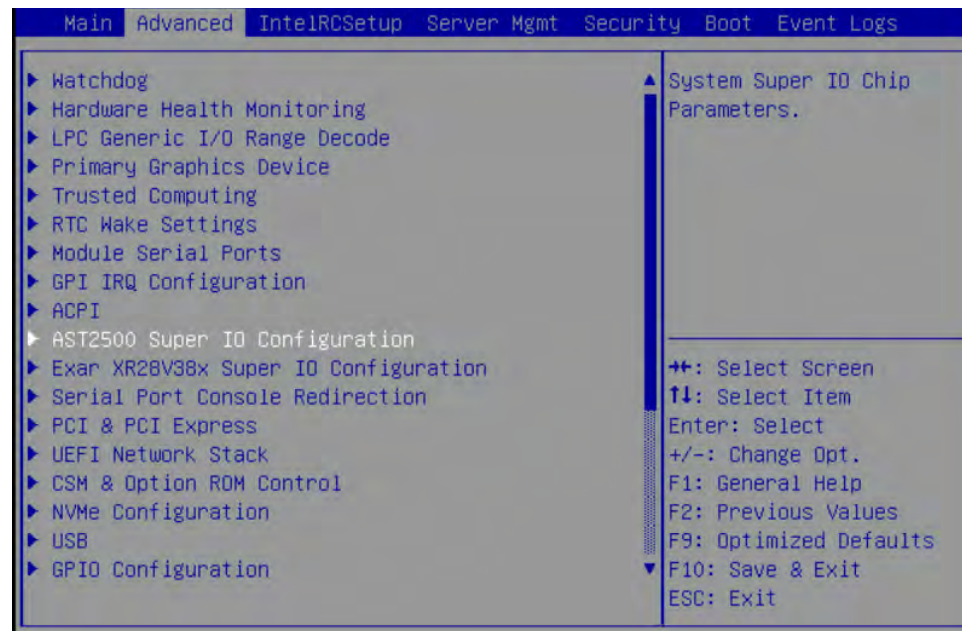

- a. Scroll down to AST2500 Super IO Configuration
 - i. Press Enter to display the Super IO configuration.
 - ii. Select Serial Port 1 Configuration and press Enter.



iii. Enable Serial Port.

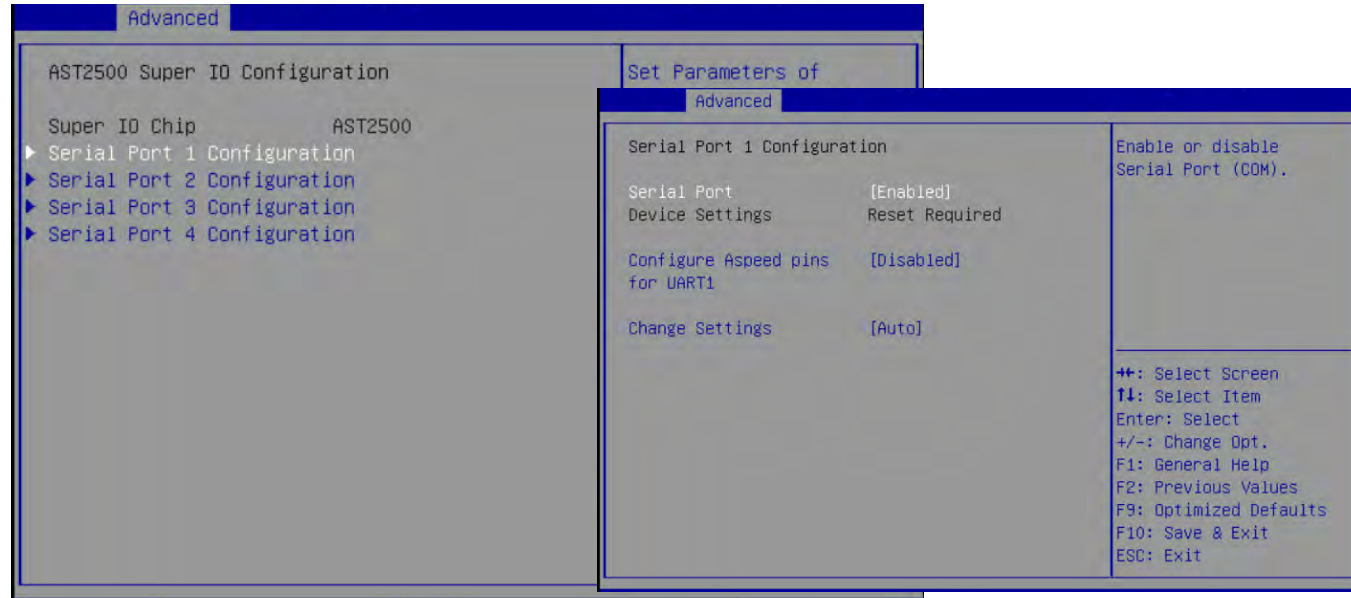

d. Scroll down to Serial Port Console Redirection.

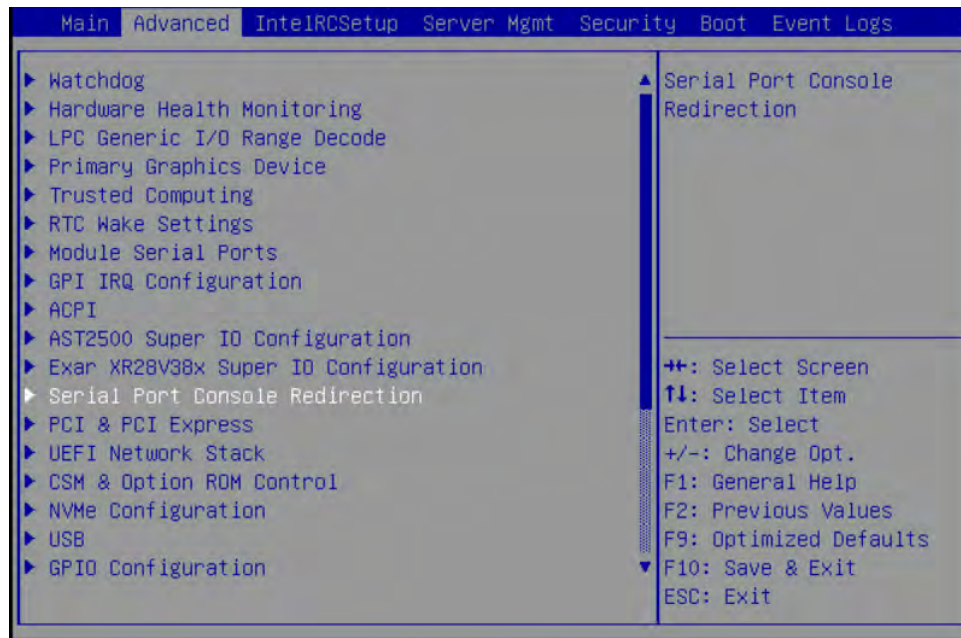



i. Press Enter to display all conga-STX7 COM ports.

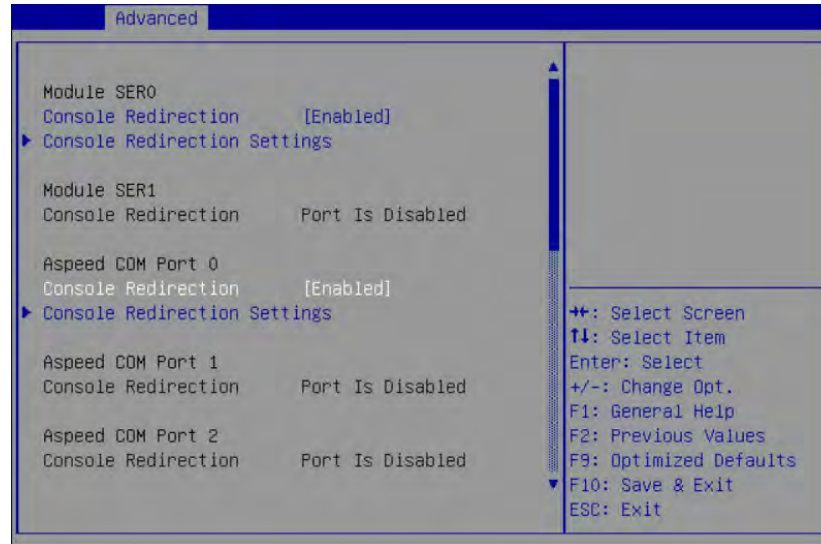

ii. Scroll down to Aspeed COM Port 0 and select Console Redirection.

iii. Press Enter and enable Console Redirection.

iv. Select Console Redirection Settings and press Enter.

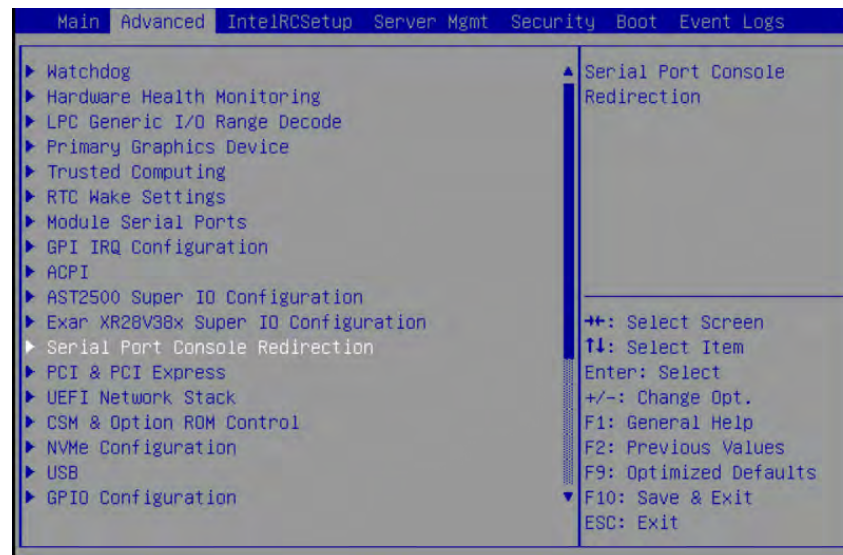



v. Configure the console redirection with the settings below.

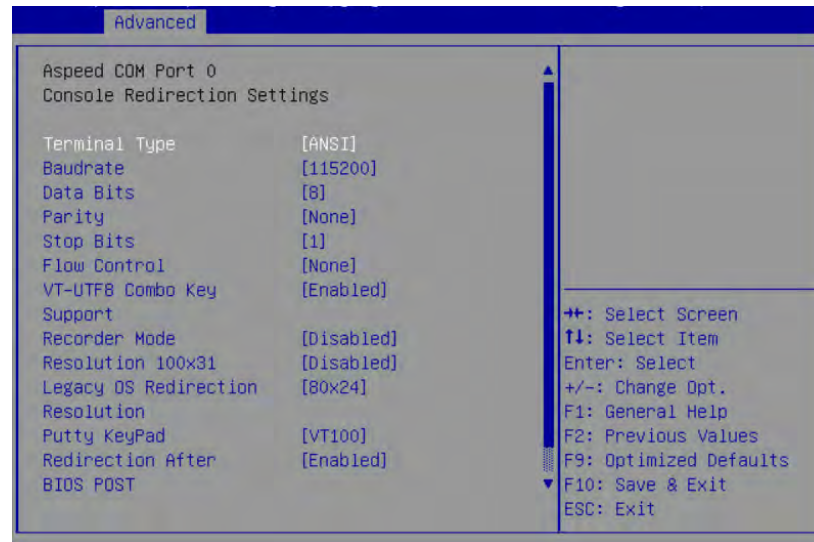

vi. Navigate to Save & Exit.

vii. Select Save Changes and Exit and then press Enter to restart the system.

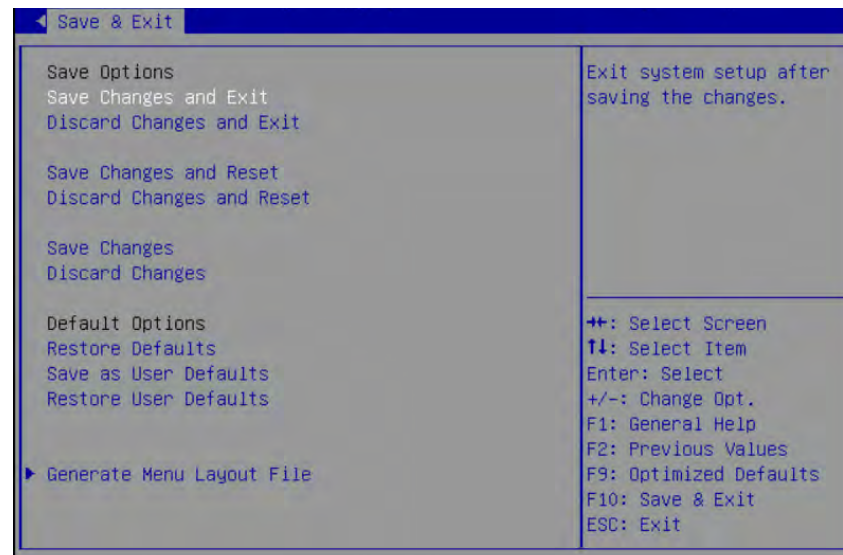



7.2.3.2 Using Serial Over LAN (SoL)

One of the ways to use SoL is through ipmiView—a GUI-based application for accessing and managing the BMC in Windows and in Linux.

1. Download the ipmiView installer from the Supermicro website at www.supermicro.com and install it.
2. Double-click the ipmiView utility to open it.
3. On the File menu, click Discover IPMI Device to open the IPMI Device Discovering window.

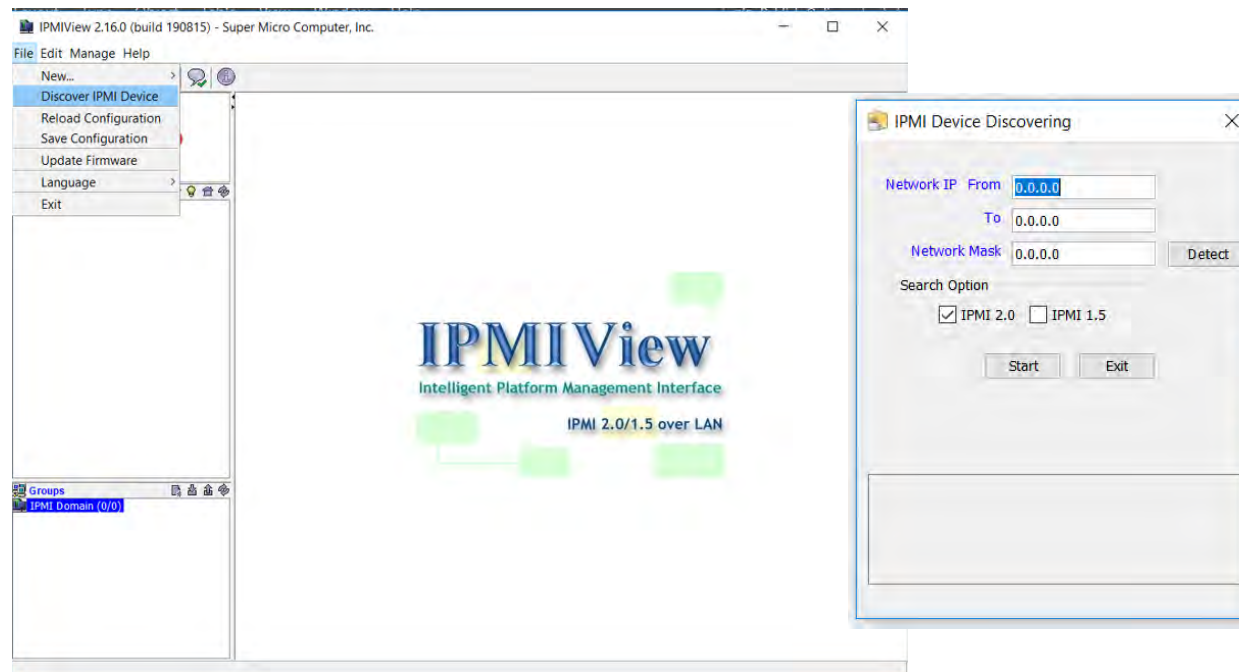

4. Enter the BMC's IP address range and network mask



5. Click **Start** to discover the BMC's IP address.

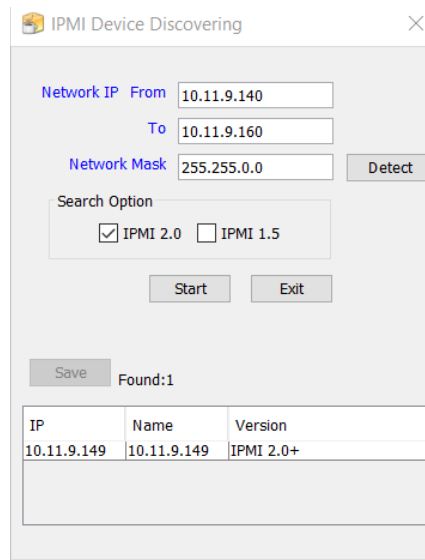

6. Highlight the discovered IP address and then click **Save**.

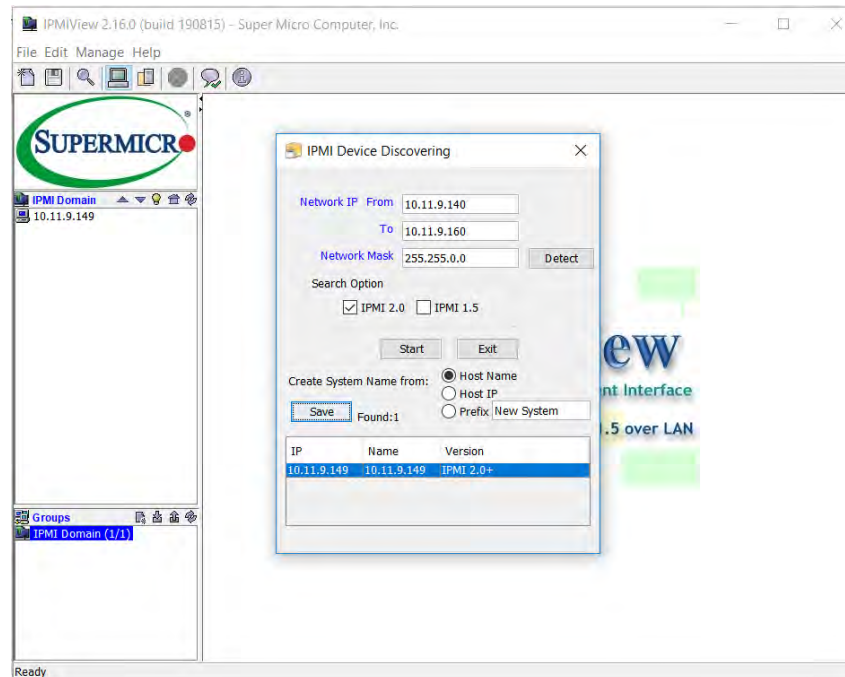



7. Click Exit to close the IPMI Device Discovering window.
8. On the left bar under IPMI Domain, double-click the saved IP address to open the login page.
9. Enter the login details:
Login ID = admin
Password = admin

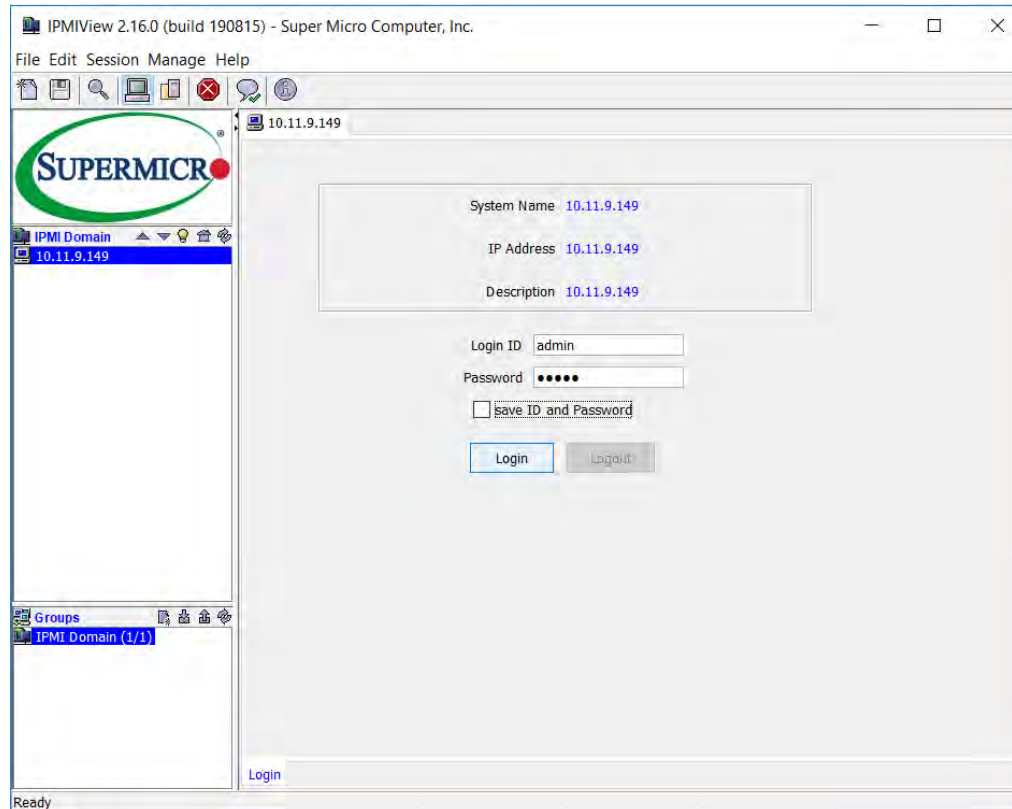

 **Note**

For security reasons, change the username and password after the first login.



10. Click Login to connect to the BMC.

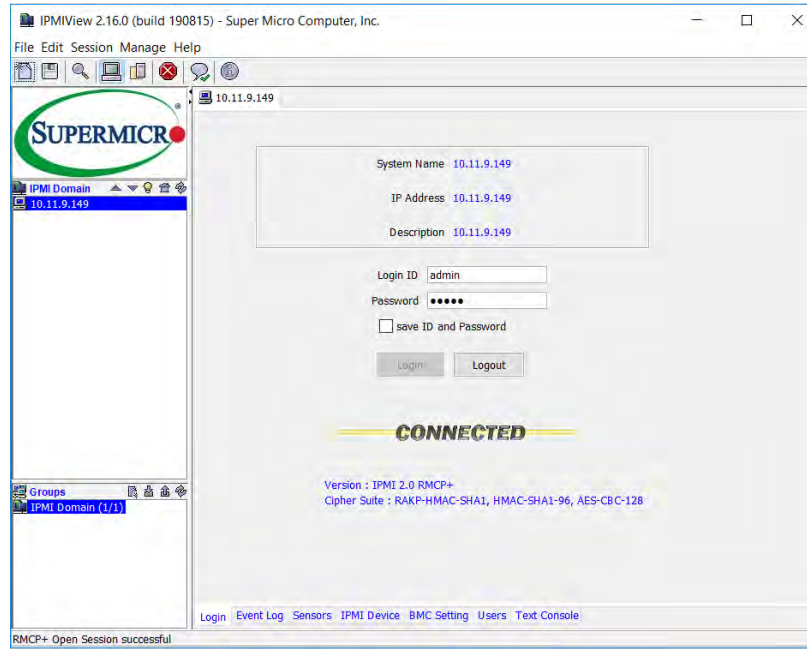

11. Click Text Console tab, at the bottom of the window and then click Start.

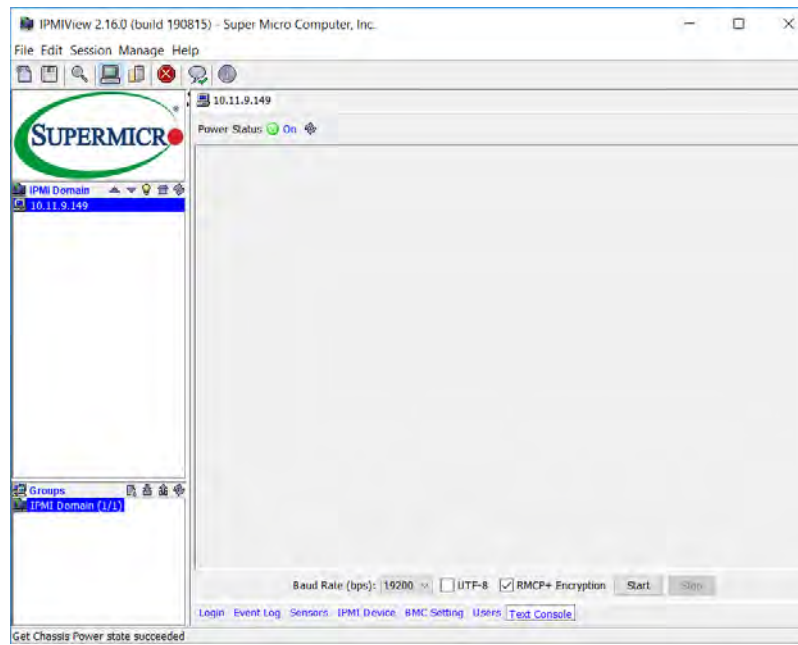



12. Click IPMI Device tab at the bottom of the window, to select chassis power control option.

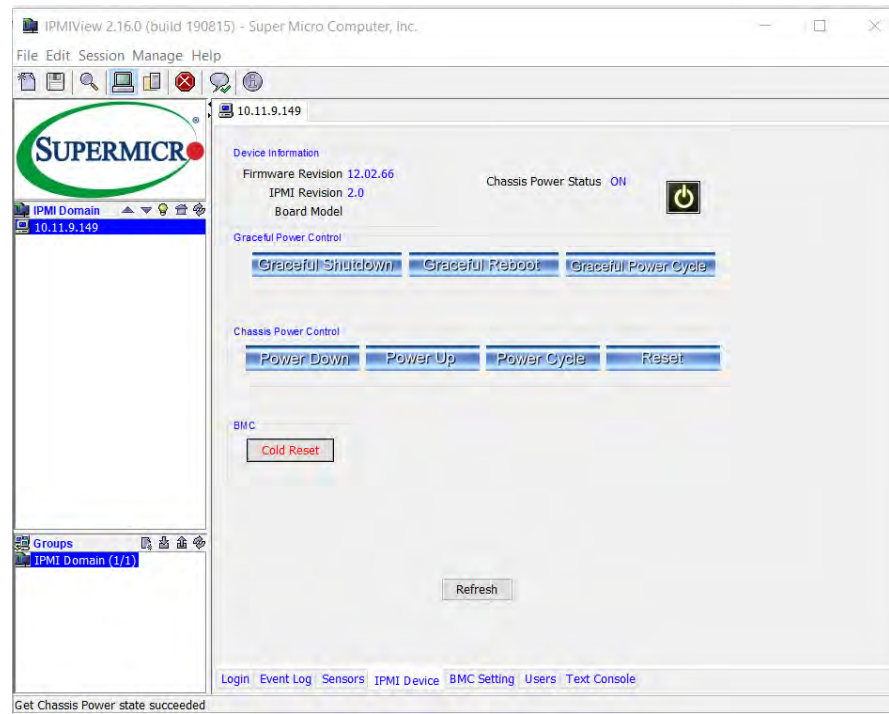

13. Click Power Cycle to restart the system.

14. Click Yes to confirm the request and then click Text Console to see the startup screen.

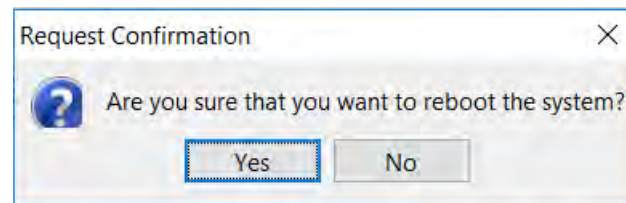



15. Press DELETE or ESC when you see "press or <ESC> to enter the BIOS setup menu".

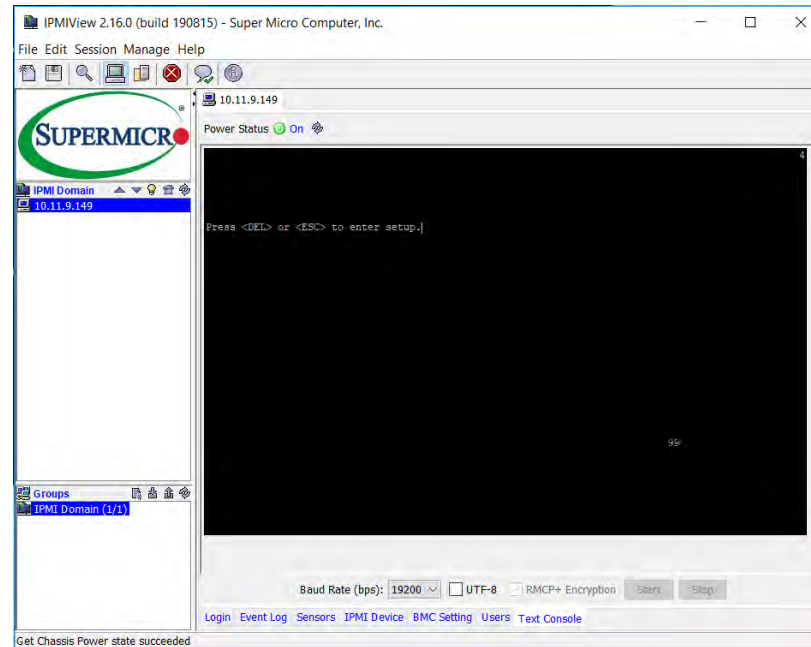

16. Use LEFT ARROW and RIGHT ARROW keys to navigate the BIOS setup menu

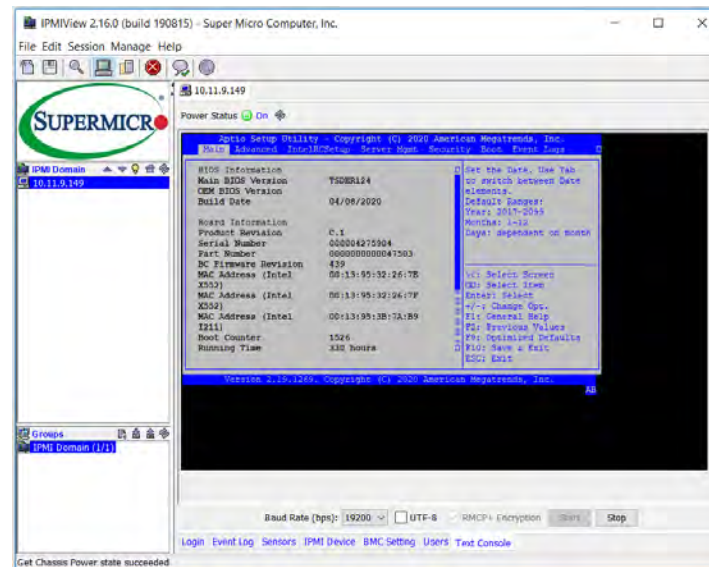



8 Additional Features

8.1 Buttons

The conga-STX7 features two push buttons—power and reset buttons. The LID and SLEEP signals are available on the feature connector.

8.1.1 Power

When using an ATX power supply, the COM Express™ module starts after the power-on button M22 is pressed.

M22

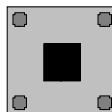

8.1.2 Reset

The COM Express™ module and all connected components will perform a hard reset when this button is pressed. The Reset button M23 is connected to the COM Express™ module's SYS_RESET# signal.

M23

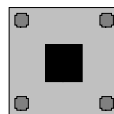

8.2 PC Speaker

The surface-mount electromagnetic buzzer M21 onboard the conga-STX7 provides audible error code (beep code) during POST.



8.3 Ground Test Points

The conga-STX7 provides two test points (M1 and M2). These test points make it easier to connect oscilloscope probes or multimeter to ground when performing measurements on the COM Express™ module.

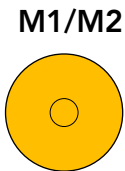

8.4 SMBus

The SMBus signals are available on the feature connector X32 described in section 4.13 “Feature Connector”. These signals are powered by the standby power rail on the COM Express module.

The devices on the conga-STX7 that use the SMB are powered by the 3.3 V main power.

8.5 I²C Bus

The I²C signals are available in different locations on the conga-STX7, including the feature connector X32 described in section 4.13 “Feature Connector”. The conga-STX7 features ATMEL AT24C16AN—a 2-wire serial EEPROM with I2C device address 0xAE.

You can access the EEPROM by using the I²C control commands implemented in the congatec CGOS API driver. Refer to the user’s guide of the COM Express™ module and the congatec CGOS manual for more information.

8.6 LPC Bus

The LPC interface from the Type 7 module is available in different locations on the conga-STX7, including the feature connector X32 described in section 4.13 “Feature Connector”.



8.7 PWR_OK

The PWR_OK signal is a high-active input from the main power supply to the module and it indicates whether the power is good. The PWR_OK signal is sourced from the onboard DC-DC regulator by default. For debugging, you can pull-up the PWR_OK signal to 3.3 V with a 1 K resistor.

8.8 Module Type Detection

The COM Express™ Specification defined four signals that indicate the pinout type of the module connected to the carrier board. These pins 'TYPE0#', 'TYPE1#', 'TYPE2#' and 'TYPE10#' are either left open (NC), strapped to ground (GND) or connected to 12 V by the module, to encode the pinout type according to the following table. For more information, refer to the COM Express™ Specification.

Table 25 Module Type Detection Pinout Description

Module Type	Pin TYPE0#	Pin TYPE1#	Pin TYPE2#	Pin TYPE10#	Comment
Module Type 6	GND	NC	NC	NC	COM Express Specification 2.0 / 3.0
Module Type 7	GND	N.C	GND	N.C	COM Express Specification 3.0
Module Type 10	X (don't care)	X (don't care)	X (don't care)	47k PD	COM Express Specification 2.0



Note

If the conga-STX7 detects an incompatible module pinout, an onboard logic prevents the board from powering up the whole system by controlling the 'PS_ON#' signal of the ATX power supply.



9 Mechanical Dimensions

